

Intermodulation Distortion (IMD) Measurements

Using the 37300 Series Vector Network Analyzer

Application Note

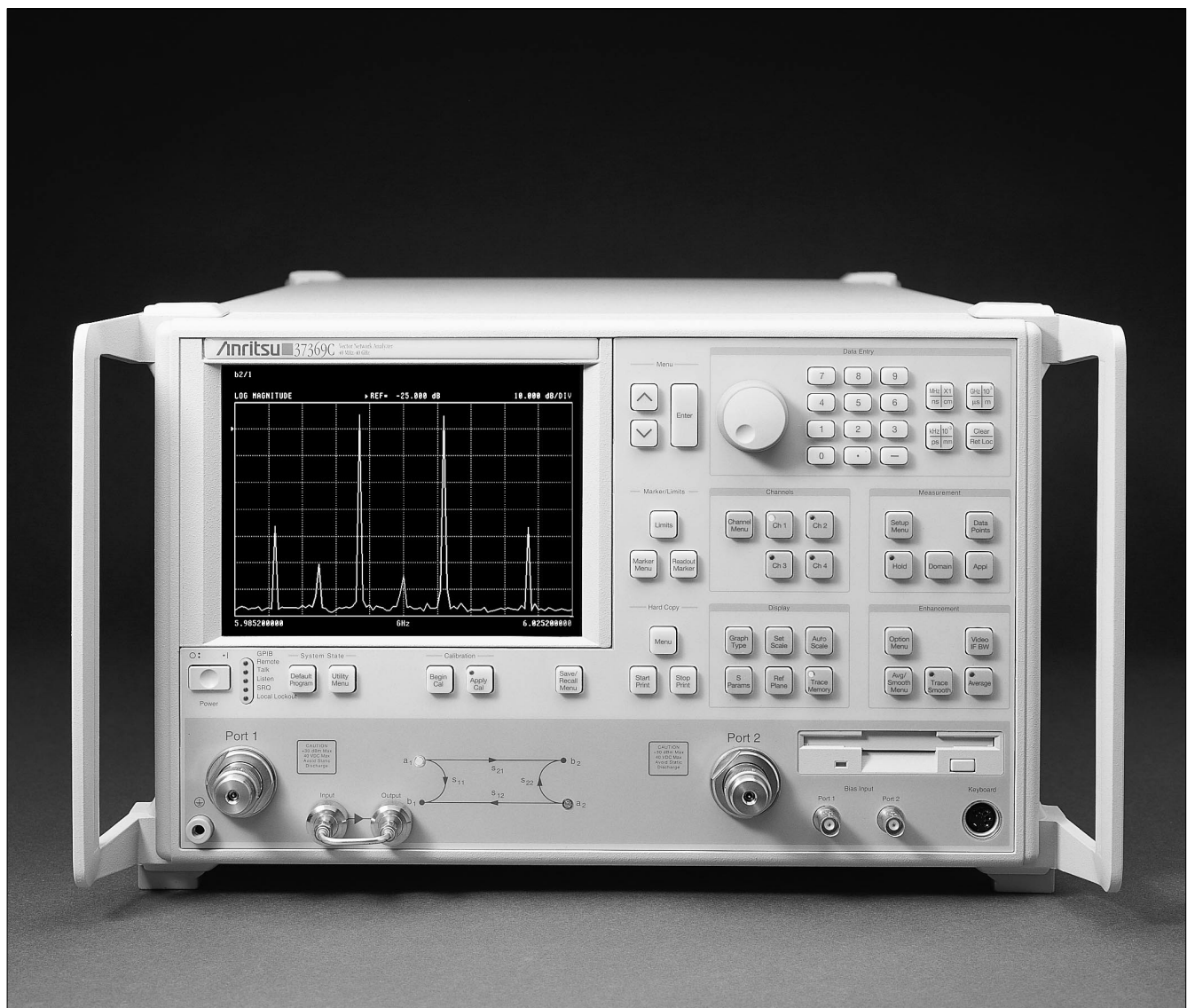

OVERVIEW

Intermodulation distortion (IMD) has become increasingly important in microwave and RF amplifier design. As modulation techniques become more sophisticated, greater performance is required from amplifier and receiver circuits. Unlike harmonic and second order distortion products, third order intermodulation distortion products (IP3) are in-band and cannot be easily filtered. Therefore, innovative designs using special feedback and feedforward techniques have been developed that greatly improve IMD performance. This enables amplifiers to operate at much higher output levels while maintaining low distortion products. As a device's intermodulation distortion is improved, greater demands are made on measurement equipment. This Application Note discusses the concept of measuring third order products using the Anritsu 373XX series of Vector Network Analyzers, in conjunction with Anritsu 68XXX or 69XXX synthesizers. Second order products will be shown for completeness, but emphasis is placed on the measurement of third order products and the calculations required to determine the swept third order intercept (TOI) point.

Harmonic Distortion

Harmonic distortion can be defined as a single-tone distortion product caused by device non-linearity. When a non-linear device is stimulated by a signal at frequency f_1 , spurious output signals can be generated at the harmonic frequencies $2f_1, 3f_1, 4f_1, \dots, Nf_1$. The order of the distortion product is given by the frequency multiplier; for example, the second harmonic is a second order product, the third harmonic is a third order product, and the Nth harmonic is the Nth order product. Harmonics are usually measured in dBc, dB below the carrier (fundamental) output signal (see Figure 1).

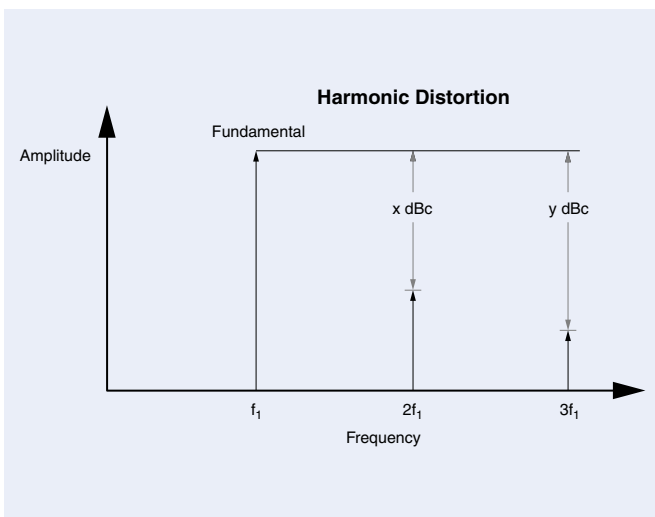

Figure 1

Intermodulation Distortion

Intermodulation distortion is a multi-tone distortion product that results when two or more signals are present at the input of a non-linear device. All semiconductors inherently exhibit a degree of non-linearity, even those which are biased for “linear” operation. The spurious products which are generated due to the non-linearity of a device are mathematically related to the original input signals. Analysis of several stimulus tones can become very complex so it is a common practice to limit the analysis to two tones. The frequencies of the two-tone intermodulation products can be computed by the equation:

$$M f_1 \pm N f_2, \text{ where } M, N = 0, 1, 2, 3, \dots$$

The order of the distortion product is given by the sum of $M + N$. The second order intermodulation products of two signals at f_1 and f_2 would occur at $f_1 + f_2, f_2 - f_1, 2f_1$ and $2f_2$ (see Figure 2 below).

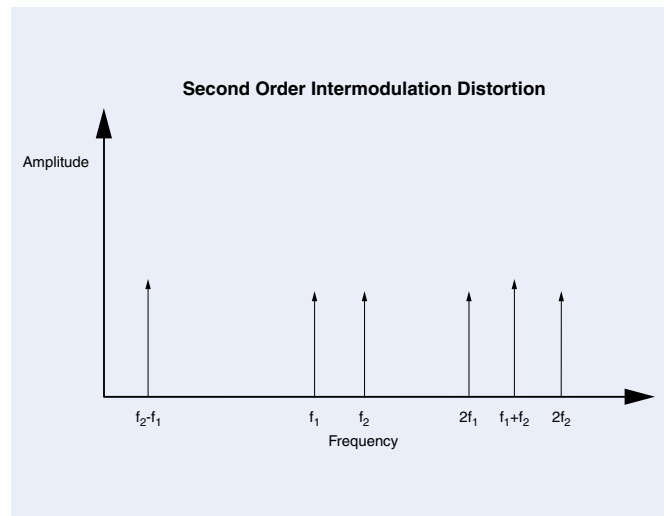

Figure 2

Third order intermodulation products of the two signals, f_1 and f_2 , would be:

$$\begin{aligned} &2f_1 + f_2 \\ &2f_1 - f_2 \\ &f_1 + 2f_2 \\ &f_1 - 2f_2 \end{aligned}$$

Where $2f_1$ is the second harmonic of f_1 and $2f_2$ is the second harmonic of f_2 .

Mathematically the $f_2 - 2f_1$ and $f_1 - 2f_2$ intermodulation product calculation could result in a “negative” frequency. However, it is the absolute value of these calculations that is of concern. The absolute value of $f_1 - 2f_2$ is the same as the absolute value of $2f_2 - f_1$. It is common to talk about the third order intermodulation products as being $2f_1 \pm f_2$ and $2f_2 \pm f_1$.

Broadband systems may be affected by all the non-linear distortion products. Narrowband circuits are only susceptible to those in the passband. Bandpass filtering can be an effective way to eliminate most of the undesired products without affecting inband performance. However, third order intermodulation products are usually too close to the fundamental signals to be filtered out. For example, if the two signals are separated by 1 MHz then the third order intermodulation products will be 1 MHz on either side of the two fundamental signals. The closer the fundamental signals are to each other the closer these products will be to them. Filtering becomes impossible if the intermodulation products fall inside the passband. As a practical example, when strong signals from more than one transmitter are present at the input to the receiver, as is commonly the case in cellular telephone systems, IMD products will be generated. The level of these undesired products is a function of the power received and the linearity of the receiver/preamplifier. Third order products are of particular concern for reasons discussed previously (see Figure 3). Second order products are of concern where interfering signals are present near twice the desired receive frequency i.e., a signal at 920 MHz and another at 921 MHz produce a spurious signal at 1.841 GHz.

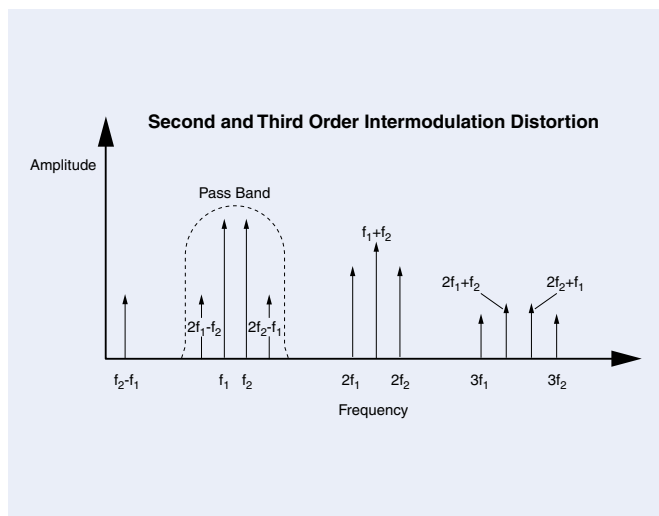

Figure 3

Amplitude Considerations

Harmonics

Harmonically related products have the characteristic that their output level will change at a rate exponential to the change of the input signal. The particular exponent is the order of the harmonic product. For example, a second order product will change at a rate that is the square of the change of input signal. The third order product will change at a rate that is the cube of the change of the input signal. For harmonic distortion, the following formula shows the relationship:

$$V_{out} = a_1 A \cos(\omega\tau) + a_2 A^2 \cos(2\omega\tau) + a_3 A^3 \cos(3\omega\tau)$$

Where a_1 , a_2 , and a_3 are transfer functions for the fundamental, second, and third harmonic. A is the amplitude of the input signal. The first term represents the fundamental signal, the second term the second harmonic, and the third term the third harmonic. Note that the second harmonic is a function of the square of the input signal and the third harmonic is a function of the cube of the input signal.

Consider the following example:

Assume that a 1 Volt input signal (+13 dBm, 50 Ohms) applied to a device generates the following:

- 10 Volt output signal (+33 dBm) at the fundamental frequency f_1
- 10 millivolt second harmonic at frequency $2f_1$ (-27 dBm)
- 1 millivolt third harmonic at frequency $3f_1$ (-47 dBm)

Ideally, in the small signal region, if the input is doubled to 2 Volts (+19 dBm) then the following will occur:

- The Fundamental output increases to 20V (+39 dBm). Note the voltage change of 2 and the power change of 6 dB.
- The second harmonic increases to 40 millivolts (-15 dBm). Note the voltage change of $2^2 = 4$, 12 dB in power.
- The third harmonic increases to 8 millivolts (-29 dBm). Note the voltage change of $2^3 = 8$, 18 dB in power. (see Figure 4).

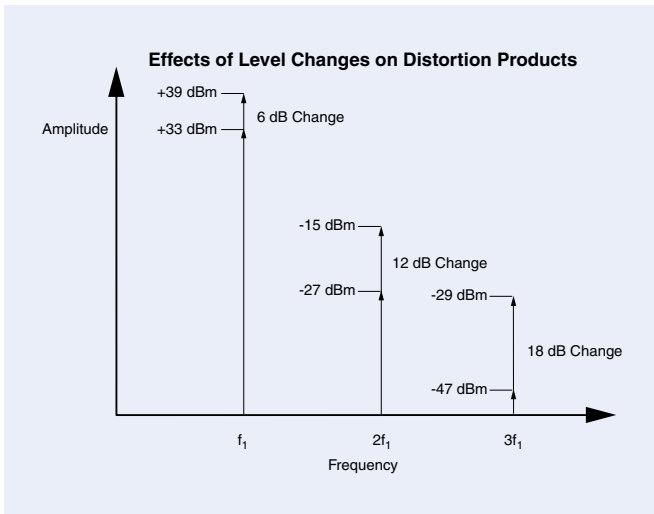

Figure 4

Intermodulation Products

This same relationship holds with intermodulation products. The second order product will increase at a rate of the input signal squared (or twice the rate in dB) and the third order product will increase at a rate of the input signal cubed (or three times the rate in dB). This relationship can be shown by the following table:

Type of Intermod Product	Frequency	Amplitude
Second Order	$f_1 + f_2$	$a_2 \cdot A_1 \cdot A_2$
	$f_1 - f_2$	$a_2 \cdot A_1 \cdot A_2$
Third Order	$2f_1 + f_2$	$a_3 \cdot A_1^2 \cdot A_2$
	$2f_1 - f_2$	$a_3 \cdot A_1^2 \cdot A_2$
	$f_1 + 2f_2$	$a_3 \cdot A_1 \cdot A_2^2$
	$f_1 - 2f_2$	$a_3 \cdot A_1 \cdot A_2^2$

Where A_1 and A_2 are the amplitudes of the two input signals. Note that the amplitude of the second order intermodulation product is a function of the product of the two input signals. If the amplitudes of A_1 and A_2 remain equal to each other then the amplitude of the second order products is a function of the product of the two input amplitudes, equivalent to the square of either one. Therefore, if both input signals change by the same amount, then the second order intermodulation product will change by a rate equal to the square of that change.

Similarly, the third order intermodulation product is a function of the square of one of the input signals, representing the second harmonic, and the fundamental of the other applied signal. If both signals are kept at the same level, then the third order intermodulation product will track changes to the applied signals by a rate equal to the cube of the input change.

Third Order Intercept Point

This exponential effect will hold true as long as the device is in the linear region, usually at 10 dB or more below the 1 dB gain compression point. The concept of an intermodulation intercept point has been developed to help quantify a device's intermodulation distortion performance. This is the point where the power of the intermodulation product intersects, or is equal to, the output power of the fundamental signal (see Figure 5). While any higher order distortion product can be evaluated using the intercept concept, this application note concentrates on the third order intercept (TOI) point. Unless otherwise noted, TOI will be referenced to the device's output power. To convert output TOI to input TOI simply subtract the gain of the device from the output TOI measurement (i.e., a 10 dB gain device with an output TOI of +20 dBm, has an input TOI of +10 dBm).

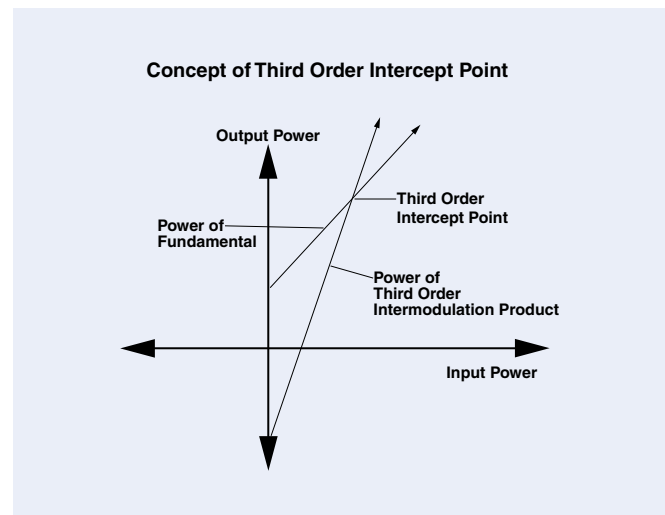

Figure 5

It is important to understand that in practice this is an unrealistic condition since the amplifier under test will saturate long before the intercept point is reached. (see Figure 6)

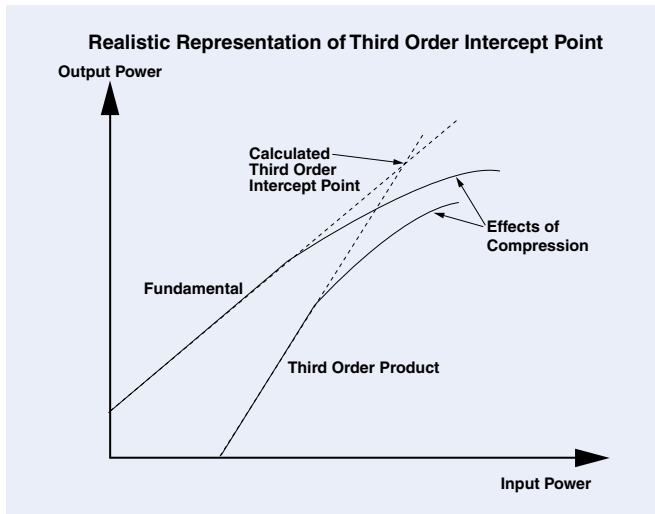

Figure 6

From the graphical representation in Figure 6, it can be seen that TOI measurements should be taken with the tones well within the small signal region of the DUT. It is common to specify that measurements be made with the device's output power below a specified point, such as below the 0.1 dB gain compression point. Typically this occurs about 10 dB or more below the 1 dB gain compression point. The third order intercept point is then extrapolated from the linear data.

Calculation of Third Order Intercept Point

The intercept point can be determined by measuring and plotting both the fundamental signal and an intermodulation product at a few different input levels, graphing the intercept point, and extrapolating the intercept. Since the power slope is known for both the fundamental signal (slope of 1) and the third order intermodulation product (slope of 3), the third order intercept point can be calculated by measuring both the fundamental signal and the intermodulation product at just one input level, and applying the following formula:

$$TOI = P_{out} + |IP_{dBc} / 2|$$

Where TOI is the third order intercept point, P_{out} is the output power of the fundamental signal, and IP is the level (in dBc) of the intermodulation product relative to the fundamental (see Figure 7). For example, if a device is driven by two signals, f_1 and f_2 , at an input of +10 dBm each, with a resulting IP of -40 dBm, then the calculated value for output TOI would be +35 dBm:

$$\begin{aligned} TOI &= +10 \text{ dBm} + |(+10 \text{ dBm} - [-40 \text{ dBm}]) / 2| \\ &= +10 \text{ dBm} + (50 / 2) \\ &= +35 \text{ dBm} \end{aligned}$$

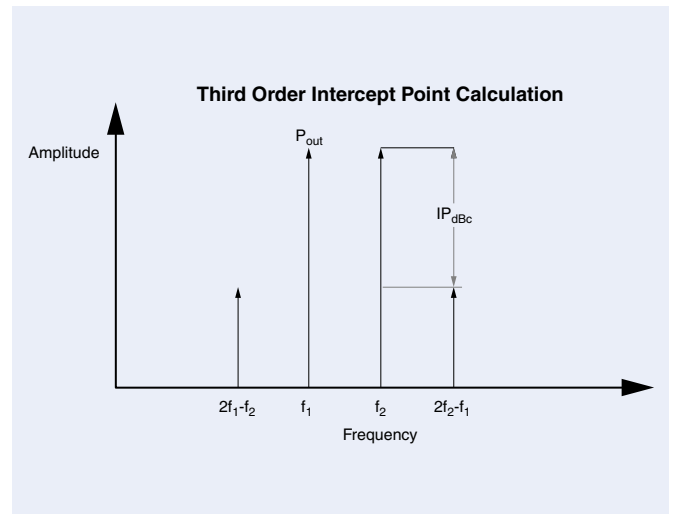

Figure 7

While it's important to take the data with the device in the linear region, from the standpoint of practical intermodulation distortion measurements, the products should be as high above the noise floor of the measuring device as possible. Using the previous example, if the input power is dropped 10 dB to 0 dBm, the third order intermodulation product will drop by 30 dB to -70 dBm. While the calculation still yields +35 dBm for the third order intercept point, making an accurate measurement of a signal at -70 dBm is much more difficult than one at -40 dBm.

Spectrum Analyzer Measurements

The following diagram, Figure 8, illustrates a traditional method of measuring TOI using a spectrum analyzer.

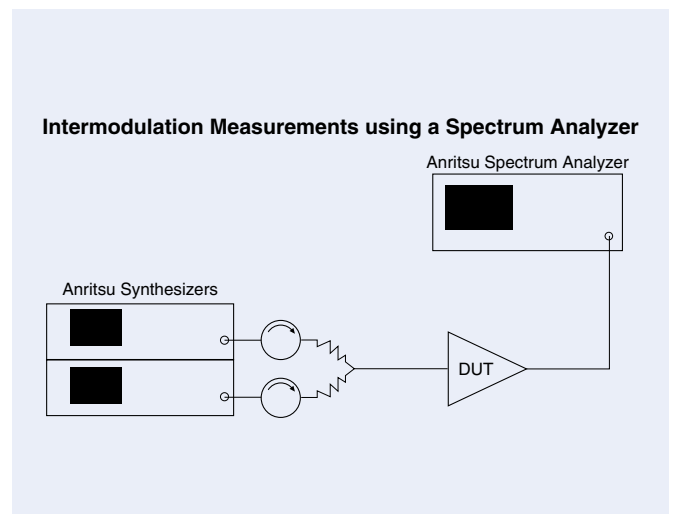

Figure 8

It is important to minimize residual intermodulation distortion caused by the measurement equipment. Without some form of isolation, the two sources can intermodulate with each other, either by the non-linear characteristics of the source output circuitry or leakage into the phase lock circuits. If an intermodulation measurement of -60 dBc is attempted with a residual intermodulation signal of -70 dBc, then the error will be about ± 2.5 dB. Ferrite isolators or attenuators can be used for decoupling the sources, however, attenuators are much wider in bandwidth than ferrites and are more readily available. It's also important to make sure that the receiver is not overdriven, causing intermodulation products on its own.

By carefully setting the RF attenuation and display scaling, spectrum analyzers can make accurate measurements of the fundamental signals, however, errors can be as high as ± 0.5 dB depending on the frequency range for the high level f_1 and f_2 signals. Another source of error is the display and marker accuracy, which can be as high as ± 2 dB over the full amplitude range of a spectrum analyzer. Insertion loss of interconnect cabling and pads will also cause measurement error. The frequency response and power measurement errors can be minimized by calibrating the system with a power meter, but this complicates the system and usually requires an external instrument controller with software. Spectrum analyzers usually have the greatest accuracy when measuring the desired signal at the top of the display. Signals measured below that point usually have an error that is inversely proportional to the level of the signal, relative to the top of the display. However, if the spectrum analyzer is set to have the intermodulation product at the top of the display, then either the mixer or log amplifiers will be overdriven by the presence of the much larger fundamental signals. Therefore, it is usually recommended that the display not be changed from the settings necessary to make accurate measurements of the fundamental products. This can present significant demands on accurate spectrum analyzer measurements. Some of the new feedforward cellular amplifiers have TOI specifications greater than 30 dB above the 1 dB gain compression point. If one assumes that TOI measurements are made at an output 10 dB to 15 dB below the 1 dB gain compression point, then this represents an output power of 40 dB or more below the TOI point. A drop of 40 dB in fundamental output power will cause the third order intermodulation product to decrease by 110 dB yielding a maximum intermodulation product of -80 dBc. This is a very demanding measurement for any measurement device. Techniques have been developed by using discrete notch filters to significantly reduce the fundamental signals so that RF attenuation can be reduced, improving measurement accuracy. However, these measurements are slow, require switched filters, and require quite complex calibration techniques. They are also limited by the filter skirts making narrow band measurements difficult. Moreover, individual filters must be used for each frequency measured, limiting the number of points that can be measured on any particular device.

Swept TOI Measurements Using the 37300 Series Vector Network Analyzer

The 373XX series VNAs offer a unique approach to TOI measurements across the full frequency range of the instrument (see Figure 9). With a 373XX VNA, and 68XXX or 69XXX series Anritsu synthesizers, accurate wide dynamic range measurements of any signals that are mathematically related to the fundamental signals can be made. This includes harmonics, amplifier intermodulation products, small signal mixing products, and mixer IM products. This capability is made possible by the 373XX's receiver design and the ability to control two of the above mentioned synthesizers simultaneously. Power level look-up tables for each synthesizer can be stored in the synthesizers themselves, thereby providing flat signals at the input to the DUT. The power level at the synthesizer output port is controlled very tightly and is typically held to within ± 0.1 dB at 0 dBm output.

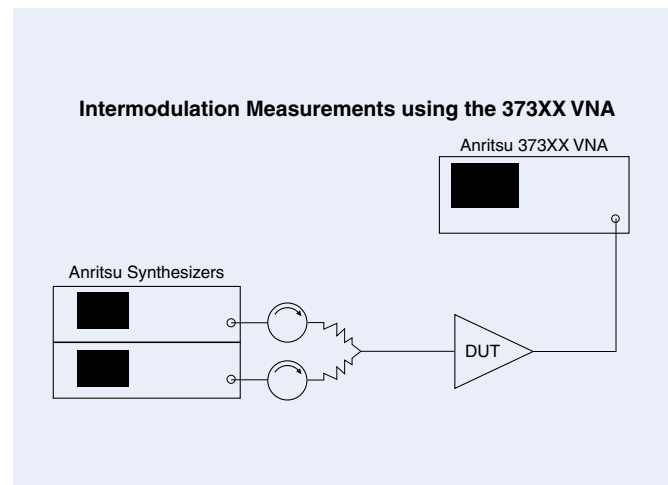

Figure 9

Since TOI calculations require the data to be entered in terms of power, and a VNA is normally used for ratio measurements, accurate absolute power measurements require the procedure described in the Appendix.

It should be pointed out, that there is no built-in pre-selection available in a VNA. Frequency selectivity comes as a result of IF rejection. The measurements described here capitalize on the fact that the frequencies of the products of interest are precisely known. They are known because they are the result of the mathematics described previously. The analyzer can receive the fundamental signals or any of the intermodulation products on a swept frequency basis, which differentiates this form of TOI measurement from other forms.

Third order product data can be taken at sufficiently high enough speed to make adjustments to the amplifier bias to optimize performance. TOI calculations can be done quickly and easily using an external PC, after the data is brought into a spreadsheet program such as Excel (typical data is plotted in Figure 10).

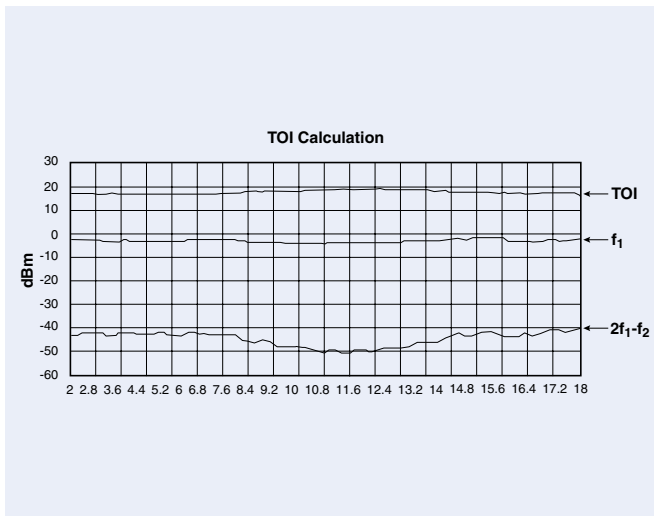

Figure 10

Accuracy of Third Order Product Measurements

The 373XX can be easily calibrated to account for frequency response and other parameters associated with this power measurement when the procedures outlined in the Appendix are followed. This method can offer accurate measurements without external controllers or custom software to control the instruments. While a VNA is at the heart of this measurement, no vector error correction is applied. However, the inherent output accuracy of the Anritsu sources can yield a power measurement accuracy of about ± 1 dB, and is dependent on how far above the noise floor the third order product is. Measurements are dependent on the quality of the output match of the Anritsu synthesizer used in normalization, and the load match of the 373XX's Port 2. Connecting a well matched 10 dB attenuator directly to the end of the Test Port cable will minimize the error. With an Anritsu 68XXX or 69XXX series synthesized generator as the source for the power calibration, and an Anritsu 41K series fixed attenuator connected to the Port 2 cable, the mismatch error will be less than ± 0.1 dB. The insertion loss of this pad, along with the loss of the test port cable and frequency response of the analyzer's receiver will all be calibrated out using the procedure outlined in the Appendix.

Receiver sensitivity is another consideration. In the mode of operation described here, the system dynamic range is on the order of 70 dB depending on the IF BW selected, the number of averages, and a two tone spacing of 10 MHz. This includes the 10 dB attenuator used to improve the uncorrected match of Port 2 and to protect the analyzer from being overdriven by the f_1 and f_2 signals.

The Anritsu 373XX VNA has the unique ability to make very fast and accurate swept Third Order Product measurements for all but the most demanding requirements. These measurements can be made without the use of an external instrument controller, GPIB software, or other instrumentation beyond the VNA and Anritsu synthesizers, although automation is certainly a possibility.

References:

Guillermo Gonzalez, *Microwave Transistor Amplifiers: Analysis and Design*, Prentice-Hall, Inc., Englewood Cliffs, NJ.

Simon S. Haykin, *An Introduction to Analog and Digital Communications*: John Wiley and Sons, Inc.

Robert Caverly and Gerald Hiller, "Distortion in p-i-n Diode Control Circuits," *IEEE Trans. MTT*, vol. MTT-35, No. 5, May 1987, pp 492 - 500.

Robert Caverly and Gerald Hiller, "Distortion in Microwave and RF Switches by Reverse Biased PIN Diodes," *IEEE MTT-S Digest*, May 1989, pp 1073 - 1076.

Chris Rice, "Techniques to Achieve Linear Amplification at HF," *RF Design*, December 1993, pp 46 - 49.

"Communication High Intercept Amplifier Handbook," 1993, AML Communications, Camarillo, CA, pp 19 - 21.

APPENDIX

Swept TOI Setup and Measurement Procedure using the 37300 VNA

Set-up the equipment as shown in Figure A1.

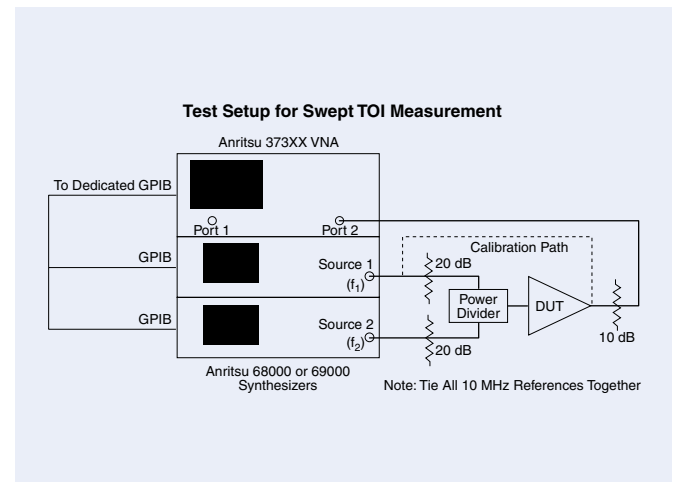

Figure A1

Equipment Required

- One 373XX VNA (with on/off control of spurious reduction)
- Two 68XXX or 69XXX synthesizers, 40 GHz
- One 3670K50-2, K(f)-K(m) cable, 25 inches
- Two RG-58 cables, BNC(m) to BNC(m)
- Two 41KC-20 or 43KC-20, 20 dB attenuator, 40 GHz
- One 41KC-10 or 43KC-10, 10 dB attenuator, 40 GHz
- One K240C, power divider, 40 GHz
- One power supply
- Two 2100-1, GPIB cables, 3.3 ft.
- Three K120MM, cables, semi-rigid, K(m) to K(m)
- Adapters, K(f) to K(f) and K(m) to K(m)

The frequencies and input power level of the two tones (f_1 and f_2) must be determined first. Setting the level of the two tones to at least 10 dB below the input 1 dB compression point should be satisfactory to ensure measurements are made in the linear region of the amplifier. If the input compression point is unknown, it can be measured first by using the swept power or swept frequency gain compression application of the 373XX VNA. The spacing between the tones is somewhat arbitrary, but typically ranges from 1 to 10 MHz, depending on the range of frequencies over which the amplifier operates. The separation should be large enough to permit the analyzer to easily separate f_1 from f_2 , but not be so large that the outputs from the two synthesizers would differ in amplitude by more than a few tenths of a dB. Spurious and image signals can also create unwanted responses as tone spacing is increased. While the 373XX VNA has a receiver response bandwidth of 1 kHz, it is recommended that the tones be spaced at 10 MHz for optimum TOI dynamic range.

What follows is a detailed procedure which can be used to test a typical amplifier. Once the equipment is set-up and calibrated, testing consists of: measuring and storing either main tone (in dBm), measuring and storing either the upper or lower third order product (in dBm), and inserting the data into a TOI calculation spreadsheet (using Microsoft Excel).

Signal Levels

Let's assume that the specifications for the amplifier are as follows (if the gain and input 1 dB compression point were unknown, they would have to be measured first):

Frequency Range:	2-18 GHz
Input 1 dB Compression Point:	-10 dBm
Gain:	24 dB

We will use a 10 MHz tone spacing and set the frequency ranges and power level into the DUT as follows:

f_1 :	2.0 GHz – 18.0 GHz
f_2 :	2.010 GHz – 18.010 GHz
Power level:	-26 dBm

The power combiner and associated circuitry must provide sufficient decoupling between the sources to prevent IMD products from being generated in the sources. For this reason, a 20 dB attenuator is installed at the output of each source. Thus, the combiner circuitry in our set-up provides over 40 dB of isolation between the sources.

The -26 dBm level into the DUT includes the 20 dB attenuator and 6 dB loss of the combiner. The output power level from the synthesizers is set to the default level of 0 dBm.

It is also necessary to determine the attenuation required at the output of the amplifier to protect Port 2 of the VNA from going into compression. With 24 dB of gain and an input level of -26 dBm for each tone, the total combined power at the output of the amplifier is approximately +1 dBm. Thus, a 10 dB attenuator is required to bring the level back down to -9 dBm, which is inside the linear range of the VNA's receiver.

Set-Up Synthesizers

To prevent confusion, Source 1 will be used as f_1 , and Source 2 will generate f_2 . In this application, the receiver must always be tuned to the same frequency, and will never be moved.

- 1) Connect a GPIB cable from Source 1 to the dedicated GPIB port on the VNA. Connect a second GPIB cable from Source 1 to Source 2.
- 2) Turn on both synthesizers. Press **SYSTEM** key and **RESET** both of them. Turn **OUTPUT RF ON**. Do not turn on the VNA at this time.
- 3) On Source 1, press **SYSTEM**, select **CONFIG**, **GPIB**, and **GPIB Address**. Set GPIB address to 4 and press **Adrs** on the key pad.
- 4) On Source 2, press **SYSTEM**, select **CONFIG**, **GPIB**, and **GPIB Address**. Set GPIB address to 5 and press **Adrs** on the key pad.

Set-Up VNA

- 1) Turn on the vector network analyzer. Press **DEFAULT DEFAULT**. Press the **UTILITY MENU** key. Move the cursor to **GPIB ADDRESSES** and press **ENTER**. Set the GPIB address to 4 for **EXTERNAL SOURCE 1** and to 5 for **EXTERNAL SOURCE 2**.
- 2) Press the **CHANNEL MENU** key and select **SINGLE CHANNEL**. Press the **CH3** button, and select **LOG MAGNITUDE** from the **GRAPH TYPE** menu.
- 3) Press **SET SCALE**. Set **RESOLUTION** to 10 dB per division, **REFERENCE VALUE** to 0 dB, and **REFERENCE LINE** to 7.
- 4) Press the **OPTION MENU** key. Select **RECEIVER MODE**. Select **SPUR REDUCTION**, and press **ENTER** (**OFF** turns red).

Each time the instrument is turned off or reset, the spur reduction mode returns to normal requiring the spur reduction to be turned off again. However, when a set-up is saved with spur reduction off, spur reduction will be off when the set-up is recalled.

Redefine S-Parameters

S-parameters are ratio (relative) measurements, and are defined in dB. Harmonic or intermodulation products are measured as an absolute power level (non-ratio) in dBm. Therefore, the S-parameters must be defined as follows:

- 1) Press the **S PARAMS** key and select S21. Press 1 to **REDEFINE SELECTED PARAMETER**. Select S21/USER 1. Press **ENTER** to switch (USER 1 turns red).
- 2) Select **CHANGE RATIO** and press **ENTER**. Under **NUMERATOR**, select B2 (Tb), and press **ENTER**. Under **DENOMINATOR**, select 1 (UNITY) and press **ENTER**. Top left of screen should display B2/1.

The analyzer is now configured to measure power, but is not yet calibrated to read in dBm.

Set-Up Multiple Source Control

The frequency for f_1 , f_2 , and the receive frequency for the VNA are entered through the **MULTIPLE SOURCE CONTROL** menu.

- 1) Press the **OPTION MENU** key, select **MULTIPLE SOURCE CONTROL**, and then **DEFINE BANDS**. Set **BAND START FREQ** to 2.0 GHz and set **BAND STOP FREQ** to 18.0 GHz. Band start and band stop frequencies become the “X” axis of the display. All directly controlled sources and receive frequencies are referenced to F, as F sweeps from band start to band stop.
- 2) Select **EDIT SYSTEM EQUATIONS**. Select **SOURCE 2** and change **OFFSET FREQ** to 0.010 GHz. This will offset Source 2 by +10 MHz from Source 1. The system equations should now read as follows:

$$\begin{aligned}\text{SOURCE 1} &= (1/1) * (F + 0.000 \text{ GHz})^{\textcircled{1}} \\ \text{SOURCE 2} &= (1/1) * (F + 0.010 \text{ GHz})^{\textcircled{2}} \\ \text{RECEIVER} &= (1/1) * (F + 0.000 \text{ GHz})^{\textcircled{3}}\end{aligned}$$

After verifying the above equations, select **PREVIOUS MENU** then **STORE BAND 1**. If an **OUT OF RANGE** error message occurs at any point in this procedure, then the band 1 start and stop frequencies must be re-entered. Any system equation that results in a frequency which falls outside the frequency range of the synthesizers or receive range of the analyzer will result in an out of range by formula error.

- 3) Select **SET MULTIPLE SOURCE MODE**, then select **ON** to set Source 1 (f_1) and Source 2 (f_2). At this point Source 1 is sweeping over the specified f_1 range. The Receiver is also tuned to f_1 by formula. Source 2 (f_2) is sweeping with a +10 MHz offset from f_1 .

Perform Power Calibration

As mentioned earlier, these measurements are absolute power, and non-ratio measurements, therefore normal VNA calibration techniques do not apply. The 373XX is normalized for power measurements by taking advantage of the inherent power flatness of Anritsu synthesizers. The following steps effectively transfer this accuracy to the VNA:

- 1) Select a Port 2 test cable which is long enough to reach both the DUT and the output connector of the Source 1 synthesizer. As shown in the equipment set-up diagram, connect a well matched 10 dB attenuator to the Port 2 test port cable, improving its match. It must be included during both calibration and measurement. This power calibration corrects for frequency flatness of the receiver, the test port cable, and any additional internal or external attenuators. If the 10 dB attenuator is insufficient to reduce the DUT output power at f_1 and f_2 to within the linear range of the VNA, then add additional internal step attenuation at Port 2 to prevent the analyzer from going into compression.
- 2) Connect the Port 2 test cable and attenuator to Source 1 as shown in Figure A1 (calibration path). Press **DATA POINTS** and set to 101 points. Press **AVG/SMOOTH MENU** and set **AVERAGING** to 100 measurements per point. Press **AVERAGE** to turn on averaging. Press **VIDEO IF BW** and set to 100 Hz. After one sweep has been completed and the display is stabilized, press **TRACE MEMORY** and select **STORE DATA TO MEMORY**. Then select **VIEW DATA (/) BY MEMORY**. Since this is not a built-in calibration procedure, the calibration light does not activate. Trace memory can also be stored to the hard disk or floppy disk for future recall.

The display is now normalized to 0 dBm (output of Source 1). This method should provide a power measuring accuracy approximately equal to the level accuracy of the synthesizer plus any mismatch error. Level accuracy of the specified sources is ± 0.1 dB at 0 dBm output. If a precision attenuator is used on the Port 2 cable, then this mismatch error will be less than ± 0.1 dB.

Before making measurements it is a good idea to check the VNA control of the synthesizers. To do this press **SETUP MENU**, select **TEST SIGNALS**, and change **SOURCE 1 PWR** to -50 dBm. Repeat for Source 2. Observe the level and flatness of the trace.

It is important that all measurements be made at the exact frequencies at which normalization/calibration was performed. If the number of data points must be changed, trace memory will be turned off, thus voiding the calibration. If this is done accidentally, return the data points to the original number and activate trace memory again. The markers and limit lines will readout in dB. Since the power calibration above was referenced to 0 dBm, then 0 dB is equal to 0 dBm.

^① Source 1 (f_1) sweeps from 2 to 18 GHz.

^② Source 2 (f_2) sweeps from 2.010 to 18.010 GHz

^③ The Receiver is set to receive from 2 to 18 GHz

Measure and Store Output Power (f_1)

Without changing Source 1, Source 2, or the Receiver frequencies, the system is set to measure f_1 power in dBm. In order to calculate the output TOI point from the third order products, the output power of one tone (f_1 in this case) must also be measured and stored to a floppy disk.

- 1) Remove the Port 2 test cable (with 10 dB attenuator attached) from Source 1 and connect it to the DUT output as shown in Figure A1. Reconnect Source 1 to the power divider (with the 20 dB attenuator in series). Apply DC power to the DUT.
- 2) Press the **MENU** key in the HARD COPY key group. Press **DISK FILE** and then under **DISK FILE OPTIONS**, select **FLOPPY DISK** and **TEXT**. Press the **START PRINT** key. Press **ENTER** (to clear the previous file name), and then enter the letters "F1," and select **DONE**. The file is stored as a DOS compatible, text file. Three columns of data are stored: the data point number, the frequency and the amplitude.

It may be desirable to also measure f_2 to verify level balance. The multiple source equations must be modified as follows and the data stored on a floppy disk.

$$\begin{aligned}\text{SOURCE 1} &= (1/1) * (F - 0.010 \text{ GHz})^{\textcircled{4}} \\ \text{SOURCE 2} &= (1/1) * (F + 0.000 \text{ GHz}) \\ \text{RECEIVER} &= (1/1) * (F + 0.000 \text{ GHz})\end{aligned}$$

In this way, the VNA can display the swept power of f_1 , f_2 , $2f_1 - f_2$ or $2f_2 - f_1$, depending on where Source 1 and 2 are tuned. While it is more intuitive to move the receiver frequency, the calibration is only valid when the analyzer receives the frequencies at which it was calibrated. For this reason the receiver frequency is never changed throughout this procedure, and only Source 1 and 2 are shifted with respect to the receiver.

A graphical representation of the tones is shown in Figure A2.

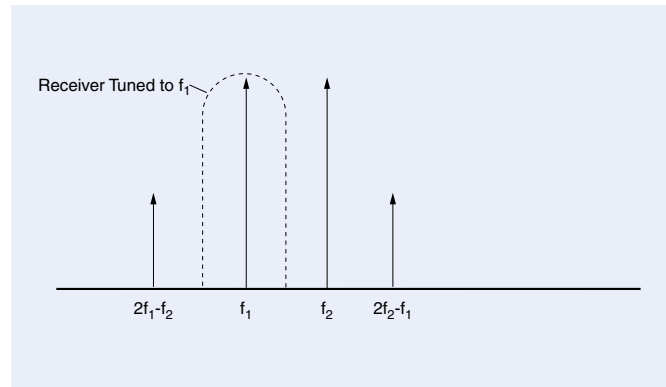

Figure A2

Measure and Store Third Order Product ($2f_1 - f_2$)

- 1) To measure the $2f_1 - f_2$ product (lower IMD product), set-up the following multiple source equations:

$$\begin{aligned}\text{SOURCE 1} &= (1/1) * (F + 0.010 \text{ GHz}) \\ \text{SOURCE 2} &= (1/1) * (F + 0.020 \text{ GHz}) \\ \text{RECEIVER} &= (1/1) * (F + 0.000 \text{ GHz})\end{aligned}$$

Figure A3 illustrates the location of the tones in this case.

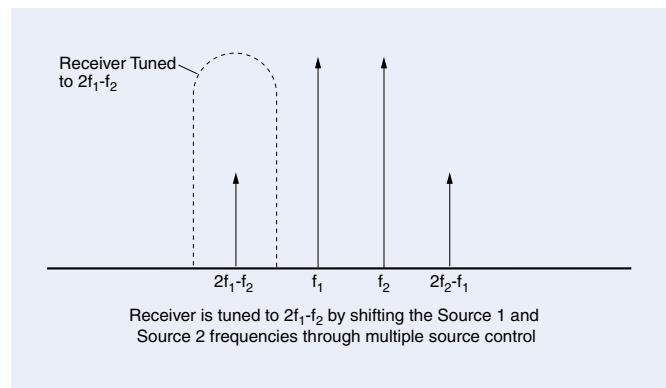

Figure A3

- 2) Store the $2f_1 - f_2$ data to the floppy disk and label it "IMDLLOWER."

If it is desirable to measure the $2f_2 - f_1$ product (upper IMD product) instead, then set:

$$\begin{aligned}\text{SOURCE 1} &= (1/1) * (F - 0.020 \text{ GHz}) \\ \text{SOURCE 2} &= (1/1) * (F - 0.010 \text{ GHz}) \\ \text{RECEIVER} &= (1/1) * (F + 0.000 \text{ GHz})\end{aligned}$$

^④ Note the minus sign. This shifts Source 1 (f_1) to a frequency which is 10 MHz below the received/calibrated frequency. Source 2 (f_2) is also shifted 10 MHz lower in frequency, placing it at the calibrated receive frequency. The receiver still sweeps from 2 to 18 GHz.

Calculate Swept TOI Point

Cut and paste the three columns of f_1 data (“F1”) into the appropriate columns of a Microsoft Excel spreadsheet defined as shown in Table A1. Repeat for $2f_1 - f_2$ data

(“IMDLLOWER”). The Excel formula used for the TOI calculation is $=ABS((C[N]-F[N])/2)+C[N]$, where C is the amplitude of f_1 (or “F1”), F is the amplitude of $2f_1 - f_2$ (or “IMDLLOWER”), and N is the appropriate row number.

The Excel spreadsheet calculates the TOI point and a graph of the TOI point versus frequency can also be plotted (see Figure A4).

Sample TOI Data

Pt. #	Freq. (GHz)	F1	Pt. #	Freq. (GHz)	IMDLLOWER	Calculated TOI
1	2	-3.147	1	2	-43.528	17.0435
2	2.16	-3.202	2	2.16	-43.679	17.0365
3	2.32	-3.149	3	2.32	-43.39	16.9715
4	2.48	-3.079	4	2.48	-43.071	16.917
5	2.64	-3.112	5	2.64	-43.135	16.8995
6	2.8	-3.23	6	2.8	-43.326	16.818
7	2.96	-3.319	7	2.96	-43.483	16.763
8	3.12	-3.375	8	3.12	-43.687	16.781
9	3.28	-3.333	9	3.28	-43.872	16.9365
10	3.44	-3.272	10	3.44	-43.331	16.7575

Table A1

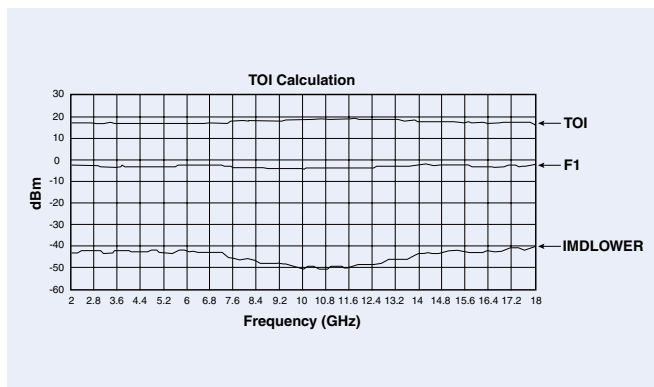
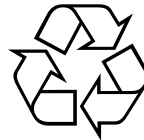

Figure A4



Certificate No. 6495

All trademarks are registered trademarks of their respective companies.

Sales Centers:

United States (800) ANRITSU
Canada (800) ANRITSU
South America 55 (21) 286-9141

Anritsu

Microwave Measurements Division • 490 Jarvis Drive • Morgan Hill, CA 95037-2809
<http://www.us.anritsu.com> • FAX (408) 778-0239

Sales Centers:

Europe 44 (01582) 433200
Japan 81 (03) 3446-1111
Asia-Pacific 65-2822400