

**MODEL 360PS20A
PULSED/CW
VECTOR NETWORK ANALYZER
SYSTEM**

OPERATION MANUAL

WARRANTY

The WILTRON product(s) listed on the title page is (are) warranted against defects in materials and workmanship for one year from the date of shipment.

WILTRON's obligation covers repairing or replacing products which prove to be defective during the warranty period. Buyers shall prepay transportation charges for equipment returned to WILTRON for warranty repairs. Obligation is limited to the original purchaser. WILTRON is not liable for consequential damages.

LIMITATION OF WARRANTY

The foregoing warranty does not apply to WILTRON connectors that have failed due to normal wear. Also, the warranty does not apply to defects resulting from improper or inadequate maintenance by the Buyer, unauthorized modification or misuse, or operation outside of the environmental specifications of the product. No other warranty is expressed or implied, and the remedies provided herein are the Buyer's sole and exclusive remedies.

TABLE OF CONTENTS

Tab / Section Title

1 GENERAL INFORMATION

Section I contains general information about the Model 360PS20A Pulsed/CW Vector Network Analyzer system, options, and specifications. Listings of related manuals and recommended test equipment are also provided.

2 INSTALLATION

Section II contains information on initial inspection, preparation for use, equipment interconnections, and GPIB setup. It also includes reshipment and storage information.

3 OPERATION

Section III contains step-by-step instructions for starting up the 360PS20A Pulsed/CW VNA system and for making pulse profile measurements. It also contains a general description of the system and the pulsed measurement process. Included in this section are the error and warning messages that may be encountered during pulsed measurements and the operator action necessary to clear each error condition.

4 OPERATION VERIFICATION

Section IV contains eight operation verification tests that can be used to verify 360PS20A Pulsed/CW VNA system operation. Setup instructions and performance procedures are included for each test. Test results can be compared with the specified limits that are provided for each test. A list of required equipment is also included.

5 SUPPLEMENTS

Supplements contains the Model 360ACM Auxiliary Control Module Maintenance Manual (WILTRON P/N 10410-00090).

360ACM Maintenance Manual

The 360ACM maintenance manual contains general information, installation instructions, and service information for the auxiliary control module. The service information includes suggested troubleshooting methods, an overall instrument interconnection diagram, a schematic of the printed circuit board, and parts lists for all field replaceable parts.

SECTION I GENERAL INFORMATION

CONTENTS

1-1	SCOPE OF THE MANUAL	1-3
1-2	INTRODUCTION	1-3
1-3	IDENTIFICATION NUMBER	1-3
1-4	RELATED MANUALS	1-3
1-5	SYSTEM DESCRIPTION	1-3
1-5.1	Computer/Controller	1-3
1-5.2	Network Analyzer	1-4
1-5.3	Test Set	1-4
1-5.4	Swept Frequency Synthesizer	1-4
1-5.5	Pulse Generator	1-4
1-5.6	Auxiliary Control Module	1-4
1-6	OPTIONS	1-5
1-7	SPECIFICATIONS	1-5
1-8	RECOMMENDED TEST EQUIPMENT	1-5



Figure 1-1. Model 360PS20A Pulsed/CW Vector Network Analyzer System

SECTION I

GENERAL INFORMATION

1-1 SCOPE OF THE MANUAL

This manual provides general information, specifications, and installation data for the Model 360PS20A Pulsed/CW Vector Network Analyzer (VNA) system. It also contains operating instructions and information for 360PS20A system setup and for making pulse profile measurements. This manual does *not* contain operating instructions and information for the standard 360 VNA system setup, calibration, CW measurements, and data display. Refer to the 360 VNA Operation Manual (P/N 10410-00104) for this information. This manual is organized as shown in the table of contents.

1-2 INTRODUCTION

This section provides general information about the Model 360PS20A Pulsed/CW VNA system, options, and specifications. Listings of related manuals and recommended test equipment are also provided.

1-3 IDENTIFICATION NUMBER

All WILTRON instruments are assigned a unique six-digit ID number. The ID number is imprinted on a decal that is affixed to the rear panel of the unit. Special-order instrument configurations also have an additional *special* serial number tag attached to the rear panel of the unit. The 360 VNA system operating software is keyed to the identification number of the 360 network analyzer.

In any correspondence with WILTRON Customer Service, please use the correct serial number with reference to that specific instrument's model number (i.e., Model 3636A Pulsed/CW Test Set, Serial No. 014022).

1-4 RELATED MANUALS

This manual is one of a multi-volume set. The manuals, listed in Table 1-1, provide operation and service information for the Model 360PS20A Pulsed/CW VNA system and related optional equipment.

NOTE

The 360PS20A Pulsed/CW VNA system requires 360 VNA operating system software Version 3.07.

1-5 SYSTEM DESCRIPTION

The Model 360PS20A Pulsed/CW VNA system (Figure 1-1) measures the phase and magnitude performance of devices during pulsed or CW RF stimulus.

The 360PS20A system consists of five main components and one auxiliary component:

- Model 360CC MS-DOS[®] Computer/Controller
- Model 360 Network Analyzer
- Model 3636A Pulsed/CW Test Set
- Model 6747B Swept Frequency Synthesizer
- Model 360PSG Pulse Generator
- Model 360ACM Auxiliary Control Module

The following paragraphs contain a brief description of each of these components.

1-5.1 Computer/Controller

The computer/controller provides overall control of the 360PS20A system. Control is implemented through menus that provide selections for measurement mode (pulsed or CW) and for setting the pulse parameters. The computer/controller directly controls the pulse generator at all times. It directly controls the network analyzer during pulse profile measurements. The computer/controller interfaces with the network analyzer and pulse generator via the GPIB (General Purpose Interface Bus).

In the pulse profile measurement mode, the computer/controller processes phase and magnitude measurement data and displays the resulting S-Parameters graphically on its color display. Menus are provided for data display enhancement and control as well as hardcopy data output.

MS-DOS[®] is a registered trademark of Microsoft Corporation.

1-5.2 Network Analyzer

Network analyzer operation is determined by the operational mode in which it is placed by the computer/controller. For pulse profile measurements, it is placed in the remote mode and receives its operating instructions and parameters from the computer/controller. For system calibration, CW measurements, and fixed pulse profile measurements, the network analyzer is placed in local mode.

When in local mode, the network analyzer is the controller, signal processor, and display unit for the system, operating virtually independent of the computer/controller (except for pulse parameter data required for the fixed pulse profile measurements). Its front panel controls provide menu selections for test functions, test parameters, measurement enhancements, and frequencies. Measurement data, test parameters, and system status are displayed on its color display and can be output to a printer or the external GPIB.

In both local and remote modes, the network analyzer sends frequency, power, and sweep information to the synthesizer over the dedicated Source Control System bus. It controls test set functions through a dedicated digital bus via the CONTROL and SIGNAL cable assemblies.

1-5.3 Test Set

The test set contains the measurement components and the pulse modulators for the 360PS20A system. The test set, under control of the network analyzer, performs:

- Stimulus-RF-signal routing from the synthesizer to the device-under-test (DUT) through one of the test ports (Port 1 or Port 2).
- Signal separation and down conversion (1st, 2nd, and 3rd IFs) of the incident-, reflected-, and transmitted-RF-signals at Ports 1 and 2 into four IF signals (Test A, Reference A, Test B, and Reference B).

The test set provides automatic signal reversing of the test ports enabling full S-parameter testing without the need to manually reverse the DUT. During pulsed measurements, the stimulus modulator generates the stimulus pulse and the profile modulators (one for each channel) generate the profile window. The test set contains couplers and attenuators capable of 20 Watts peak forward power. It also contains provisions for external power ampli-

fiers and high power terminations. The frequency range of the test set is 890 MHz to 20 GHz.

1-5.4 Swept Frequency Synthesizer

The swept frequency synthesizer is the RF signal source for the 360PS20A system. It provides the stimulus signal to the DUT via the test set. The synthesizer is controlled by the network analyzer through the dedicated Source Control System bus. To assure coherent detection of test signals, the synthesizer is locked to the 10 MHz reference time base of the network analyzer. Frequency resolution during the CW mode of operation (receiver synthesizer/tracking mode) is 1 kHz; resolution during the pulsed mode of operation (receiver set on mode) is 100 kHz.

Although the 360PS20A system comes equipped with a WILTRON 6747B swept frequency synthesizer, any WILTRON model 6700B swept frequency synthesizer operating over the frequency range of 890 MHz to 20 GHz may be used.

1-5.5 Pulse Generator

The system pulse generator provides two pulses to the test set; one to the stimulus modulator and one to each profile pulse modulator. These pulses trigger the modulators to create the stimulus pulse and the profile window. The pulses produced by the pulse generator are precisely controlled for pulse width, pulse delay, and pulse repetition frequency (PRF). The pulse generator is directly controlled by the computer/controller through the GPIB. For synchronization, it is locked to the network analyzer's 10 MHz reference time base via the frequency synthesizer. Its trigger source can be internal or external.

The 360PSG pulse generator is housed within the 360ACM auxiliary control module. The operation and service manual for the 360PSG pulse generator is included in the Supplements section of this manual.

1-5.6 Auxiliary Control Module

The auxiliary control module is a 360PS20A system auxiliary unit. It supplies -15 Vdc to the system test set and provides housing and primary power for the system pulse generator.

The maintenance manual for the 360ACM auxiliary control module is included in the Supplements section of this manual.

1-6 OPTIONS

The following options are available for the Model 360PS20A Pulsed/CW VNA system.

Option 1 — Delete Computer/Controller and Console. This option deletes the Model 360CC MS-DOS[®] Computer/Controller and the Model 360C4 Computer Console for applications in which an alternate computer/controller is used to control the pulsed measurement process.

Option 2 — Portable Computer/Controller. This option replaces the standard desktop Model 360CC MS-DOS[®] Computer/Controller and the Model 360C4 Computer Console with a portable Model 360CC Computer/Controller. The portable Model 360CC is hardware equivalent to the standard desktop computer/controller. It has a monochrome VGA (plasma) display.

The power requirements are 115 (104 - 127) Vac, 220 to 240 (198 - 264) Vac, 50 to 60 (49 - 61) Hz. It

weighs approximately 39.6 kg (18 lbs), and has the following dimensions:

91.4 H x 370.6 W x 396.2 D mm
(3.6 H x 14.6 W x 15.6 D in.)

1-7 SPECIFICATIONS

Table 1-2 lists those specifications that are unique to the Model 360PS20A Pulsed/CW VNA system.

A complete listing of the Model 360 VNA specifications can be found in Section I of the Model 360 Vector Network Analyzer Operation Manual, P/N 10410-00022. Specifications for the Model 6747B Swept Frequency Synthesizer are listed in Section I of the Series 67XXB Swept Frequency Synthesizer Operation Manual, P/N 10370-10202.

1-8 RECOMMENDED TEST EQUIPMENT

Table 1-3 provides a list of recommended test equipment that covers the basic needs of fault isolation and servicing of the 360PS20A Pulsed/CW VNA system.

Contact WILTRON Customer Service at (408) 778-2000 for help regarding test equipment compatibility.

Table 1-1. List of Related Manuals

Manual Title	Abbreviation	Description	Part Number
Model 360 Vector Network Analyzer Operation Manual	360 OM	This manual provides general information, specifications, installation data, and operating instructions and information for the Model 360 Vector Network Analyzer system.	10410-00104
Model 360PS20A Pulsed/CW Vector Network Analyzer Operation Manual	360PS20A OM	This manual provides general information, specifications, installation data, and operating instructions and information for the Model 360PS20A Pulsed/CW Vector Network Analyzer system.	10410-00094
Model 360 Vector Network Analyzer GPIB Programming Manual	360 GPIB PM	This manual provides complete GPIB programming instructions and information for the Model 360 Vector Network Analyzer system.	10410-00070
Model 360 Network Analyzer Maintenance Manual	360 MM	This manual provides service information for the 360 Network Analyzer. It includes parts lists, circuit descriptions, block diagrams, schematic diagrams, and removal and replacement procedures for the Network Analyzer subassemblies.	10410-00032
Model 3636A Test Set Maintenance Manual	3636A TS MM	This manual provides service information for the Model 3636A Pulsed/CW Test Set. It includes parts lists, circuit descriptions, block diagrams, schematic diagrams, and removal and replacement procedures for certain test set subassemblies.	10410-00096
Series 67XXB Swept Frequency Synthesizer Operation Manual	67XXB OM	This manual provides general information, specifications, installation data, and local (front panel) and remote (GPIB) operating instructions and information for all models in the Series 67XXB Swept Frequency Synthesizer family.	10370-10202
Model 6747B Swept Frequency Synthesizer Test and Calibration Manual	6747B T&C	This manual provides performance verification test procedures, calibration and adjustment procedures, and test records for the Model 6747B Swept Frequency Synthesizer.	10370-10228
Series 67XXB Swept Frequency Synthesizer Maintenance Manual	67XXB MM	This manual provides service information for all models of the Series 67XXB Swept Frequency Synthesizer family. It includes parts lists, circuit descriptions, block diagrams, schematic diagrams, and troubleshooting information.	10370-10242
Model 36XX Calibration and Verification Kit Manuals	36XX CK & VK OMM	This manual provides operating instructions and maintenance information for the Models 3650, 3651, 3652, and 3653 Calibration Kits and the Models 3666, 3667, and 3668 Verification Kits.	10100-00024
Model 360 Performance Verification Software User's Guide	2300-62/63 SUG	This manual provides operating information for the Model 360 VNA Performance Verification Software, WILTRON part numbers 2300-62 and 2300-63.	10410-00060
3680 Series Universal Test Fixture Operation and Maintenance Manual	3680 UTF OMM	This manual provides general information, operating instructions, calibration procedures, and maintenance information for the 3680 Series Universal Test Fixture and optional accessories.	10410-00064

Table 1-2. Specifications for the Model 360PS20A Pulsed/CW VNA System (1 of 2)

Frequency Range: 890 MHz to 20 GHz
Pulse Width (PW): 20 ns to CW
Duty Factor: 0.1% to CW
Pulse Repetition Frequency (PRF):
 Minimum: 1 kHz
 Maximum: 980 kHz (limited by the system pulse generator)
Power Handling: 20 Watts, peak (10 Watts, average)
Equivalent Bandwidth: > 50 MHz
Pulse Delay: $0 \mu\text{s to } \left(\frac{1}{\text{PRF}} - 1 \mu\text{s} - \text{PW}\right)$
External Trigger Width: $\geq 5 \text{ ns}$
External Trigger Delay: $< 85 \text{ ns}$

Dynamic Range Summary: ①

Frequency	890 MHz	2 GHz	20 GHz
Maximum Signal ② into Port 2 (dBm)	+ 43	+ 43	+ 43
Noise Floor (dBm)	-105	-108	-91
Receiver Dynamic Range ③ (dB)	148	151	134
Port 1 Power ③ (dBm, typical)	- 5	- 5	- 8
System Dynamic Range ③ (dB)	100	103	83

Test Port Characteristics (K Connectors):

Frequency	890 MHz	2 GHz	20 GHz
Directivity (dB)	> 42	> 42	> 42
Source Match (dB)	> 40	> 40	> 38
Load Match (dB)	> 42	> 42	> 42
Reflection Frequency ④ Tracking (dB)	± 0.020	± 0.020	± 0.030
Transmission Frequency ④ Tracking (dB)	± 0.030	± 0.050	± 0.070
Isolation (dB)	>105	>115	>110

① Dynamic range is specified using two methods. "Receiver Dynamic Range" is defined as the ratio of the maximum signal level at Port 2 for 0.1 dB compression to the noise floor at Port 2. "System Dynamic Range" is defined as the ratio of power incident on Port 2 in a through line connection to the noise floor at Port 2 (forward measurements only). In preparing the Dynamic Range Summary table, minimum IF Bandwidth and 1024 averages were used in calibration and measurement. Changes in the Video IF Bandwidth or averaging can result in variations at low levels.

② With high power termination and using internal step attenuator

③ For pulsed measurements, average Port 1 power, receiver dynamic range, and system dynamic range are reduced by 20log (duty factor).

④ For CW measurements, using the Synthesizer/Tracking Mode.

⑤ For pulsed measurements, transmission uncertainty curves are shifted to the left by 20log (duty factor).

Measurement Uncertainty Curves:
 Model 3636A Test Set (K Connectors)
 Reflection Measurements:

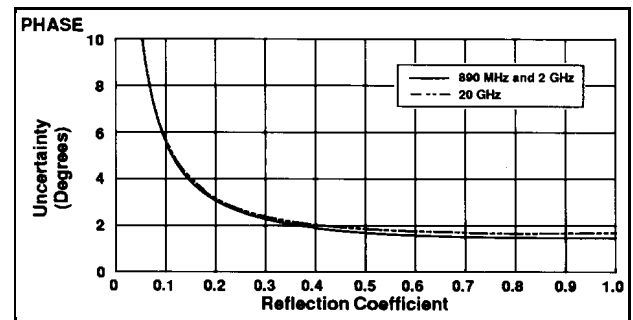
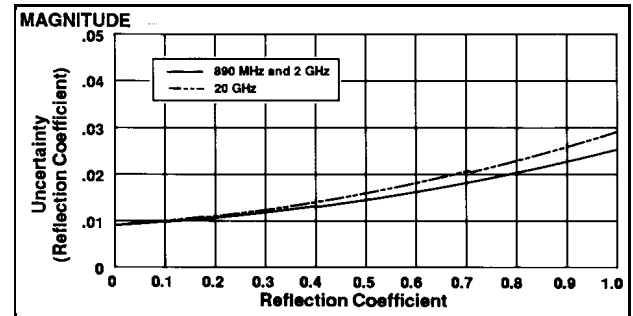

Transmission Measurements: ⑤

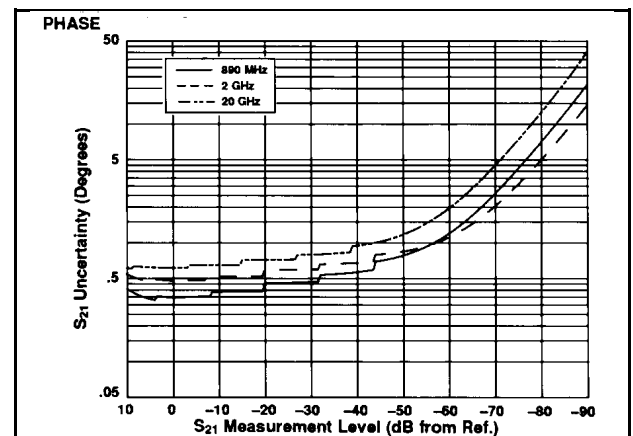
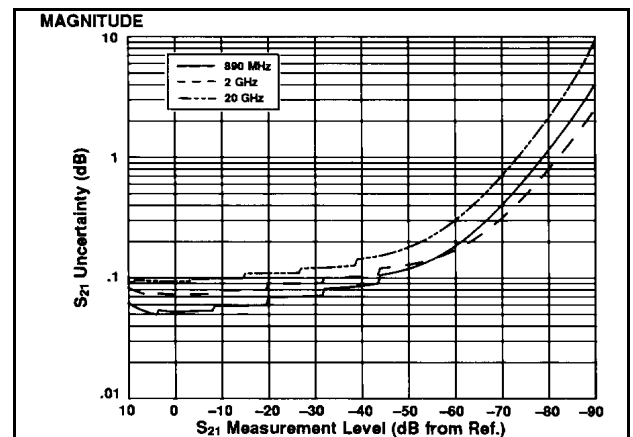

Table 1-2. Specifications for the Model 360PS20A Pulsed/CW VNA System (2 of 2)

COMPUTER/CONTROLLER	GENERAL (continued)
<p>The 360CC MS-DOS[®] Computer/Controller has a 20 MHz 80386 microprocessor and 80387 numeric coprocessor with 2 Mbytes of RAM, a 3.5-inch/1.44 Mbyte disk drive, and a 40 Mbyte hard disk drive. The 14-inch color VGA monitor has 640x480 pixels with 256 colors. The keyboard is a 101-key, enhanced AT-type keyboard. A parallel printer port and an RS-232 serial port provide input/output capability. A National Instruments GPIB-PCII (IEEE-488) Interface card provides the interface between the computer/controller, the 360 VNA, and the 360PSG pulse generator. The 360CC comes fully assembled with MS-DOS[®] and the pulse application software on the hard disk, factory-installed and tested.</p>	<p>Power Requirements: 360CC Computer/Controller: 120/240 V, 60/50 Hz, 325 VA maximum 360CC Monitor: 120 V, 60 Hz, 120 VA maximum (powered via the 360CC Computer/Controller) 360PSG Pulse Generator: 100/120/220/240 V, 60/50 Hz, 120 VA maximum 2225C Printer: 9 Vac, 13.5 VA maximum, adapter Printer Buffer: 9 Vdc, 9 VA maximum, adapter 360ACM Auxiliary Control Module: 100/120/220/240 V, 60/50 Hz, 540 VA maximum</p>
<p>PULSE GENERATOR</p> <p>The 360PSG Pulse Generator is both a four channel digital delay generator and a two channel precision pulse generator. The four programmable time intervals define the two output pulses (AB and CD) in precisely controlled pulse widths. The pulse generator is controlled by the computer/controller via the GPIB. The instrument is locked to the 10 MHz reference time base of the 360 network analyzer via the frequency synthesizer. The pulse generator can be internally or externally triggered.</p>	<p>Dimensions: 360CC Computer/Controller: 165H x 533W x 432D mm (6.5H x 21W x 17D in.) 360CC Monitor: 394H x 369W x 406D mm (15.5H x 14.5W x 16D in.) 360PSG Pulse Generator: 121H x 216W x 356D mm (4.75H x 8.5W x 14D in.) 2225C Printer: 89H x 292W x 203D mm (3.5H x 17W x 23.75D in.) Printer Buffer: 70H x 225W x 148D mm (2.75H x 8.85W x 5.8D in.) 360ACM Auxiliary Control Module: 133H x 432W x 603D mm (5.25H x 17W x 23.75D in.) 360C4 Computer Console: 889H x 648W x 724D mm (35H x 25.5W x 28.5D in.)</p>
<p>Pulse Width (PW): 20 ns to CW Pulse Repetition Frequency (PRF): 1 kHz to 980 kHz Pulse Delay: 0 μs to $\left(\frac{1}{\text{PRF}} - 1 \mu\text{s} - \text{PW}\right)$</p>	<p>Weight: 360CC Computer/Controller: 16.8 kg (37 lb.) 360CC Monitor: 13.6 kg (30 lb.) 360PSG Pulse Generator: 4.5 kg (10 lb.) 2225C Printer: 3.2 kg (7 lb.) Printer Buffer: 1.8 kg (4 lb.) 360ACM Auxiliary Control Module: 10.7 kg (23.5 lb.) 360C4 Computer Console (Empty): 31.4 kg (69 lb.)</p>
<p>HARD COPY</p> <p>Printer</p> <p>Three printer types are supported – the HP Deskjet printer type, the Epson (EX, FX, LX, and compatible) printer type, and the HP Thinkjet printer type. The selection is made during system start up. The system is shipped from the factory with a WILTRON 2225C Inkjet (HP Thinkjet compatible) printer. The printer interface is Parallel (Centronics). An output menu allows selection of full screen, graphical, or tabular data output.</p>	
<p>Printer Buffer</p> <p>A separate hardware printer buffer enables the network analyzer and the computer/controller to share the printer. Hard-copy data is received at high speed and stored in buffer memory (256K bytes of RAM). Full operation and measurement capability is then restored to the user during the remainder of the hard-copy generation.</p>	
<p style="text-align: center;">GENERAL</p> <p>Temperature Range: Operating: 0°C to 50°C Storage: – 40°C to 75°C</p>	

Table 1-3. List of Recommended Test Equipment

Instrument	Critical Specification	Recommended Manufacturer/Model
Spectrum Analyzer	<i>Frequency:</i> 10 kHz to 20 GHz <i>Resolution:</i> 10 Hz	Tektronix, Inc. Model 494P
Power Meter, with Power Sensor	<i>Power Range:</i> -30 to +20 dBm (1 μ W to 100 mW)	Hewlett-Packard Model 436A, with Power Sensor: HP 8485A (50 MHz to 26.5 GHz)
Digital Multimeter	<i>Resolution:</i> 4-1/2 digits <i>DC Accuracy:</i> 0.002% +2 counts <i>DC Input Impedance:</i> 10 M Ω <i>AC Accuracy:</i> 0.07% +100 counts (to 20 kHz) <i>AC Input Impedance:</i> 1 M Ω	John Fluke, Inc. Model 8840A, with Option 8840A-09 (True RMS AC)
Frequency Counter	<i>Frequency Range:</i> 10 Hz to 20 GHz <i>Input Impedance:</i> 50 Ω <i>Resolution:</i> 1 Hz <i>Other:</i> External Time Base Input	EIP Microwave, Inc. Model 578A
Oscilloscope	<i>Bandwidth:</i> DC to 150 MHz <i>Vertical Sensitivity:</i> 2 mV/division <i>Horizontal Sensitivity:</i> 20 ns/division	Tektronix, Inc. Model 2445

SECTION II INSTALLATION

CONTENTS

2-1	INTRODUCTION	2-3
2-2	INITIAL INSPECTION	2-3
2-3	PREPARATION FOR USE	2-3
2-4	CHANGING THE LINE VOLTAGE	2-15
2-5	GPIB SETUP AND INTERCONNECTIONS	2-16
2-5.1	Interface Connector	2-16
2-5.2	Cable Length Restrictions	2-16
2-5.3	GPIB Interconnections	2-16
2-5.4	GPIB Addresses	2-16
2-6	PREPARATION FOR STORAGE AND/OR SHIPMENT .	2-17
2-6.1	Preparation for Storage	2-17
2-6.2	Preparation for Shipment	2-17

SECTION II INSTALLATION

2-1 INTRODUCTION

This section provides information on initial inspection, preparation for use, equipment interconnections, and GPIB setup. It also includes reshipment and storage information.

2-2 INITIAL INSPECTION

Inspect the shipping container for damage. If the container or cushioning material is damaged, retain until the contents of the shipment have been checked against the packing list and the instrument has been checked for mechanical and electrical operation.

If any of the 360PS20A system instruments or components are damaged mechanically, notify your local sales representative or WILTRON Customer Service. If either the shipping container is damaged or the cushioning material shows signs of stress, notify the carrier as well as WILTRON. Keep shipping materials for the carrier's inspection.

2-3 PREPARATION FOR USE

The 360PS20A system comes packaged in twelve boxes. Preparation for use consists of the following:

1. Inventorying the shipment, including the accessory-parts kit (two boxes).
2. Unpacking the equipment.
3. Assembling the 360C1 system console and the 360C4 computer console.
4. Installing the system instruments.
5. Installing the shelf in the system console.
6. Cabling the system instruments.
7. Checking the line voltage setting; resetting for the line-voltage value in your area, if appropriate.

Figure 2-1 shows the items in the attaching-parts kit, and Table 2-1 provides a listing of the hardware. Using the illustration and table, ensure that all of the required parts are available before beginning the assembly of the system. The steps required to assemble the system are given in Figure 2-2.

NOTE

The empty 360C1 system console weighs 65.9 kg (145 lb). We recommend employing two or more people to lift it off of the shipping pallet (Figure 2-2, Step 2).

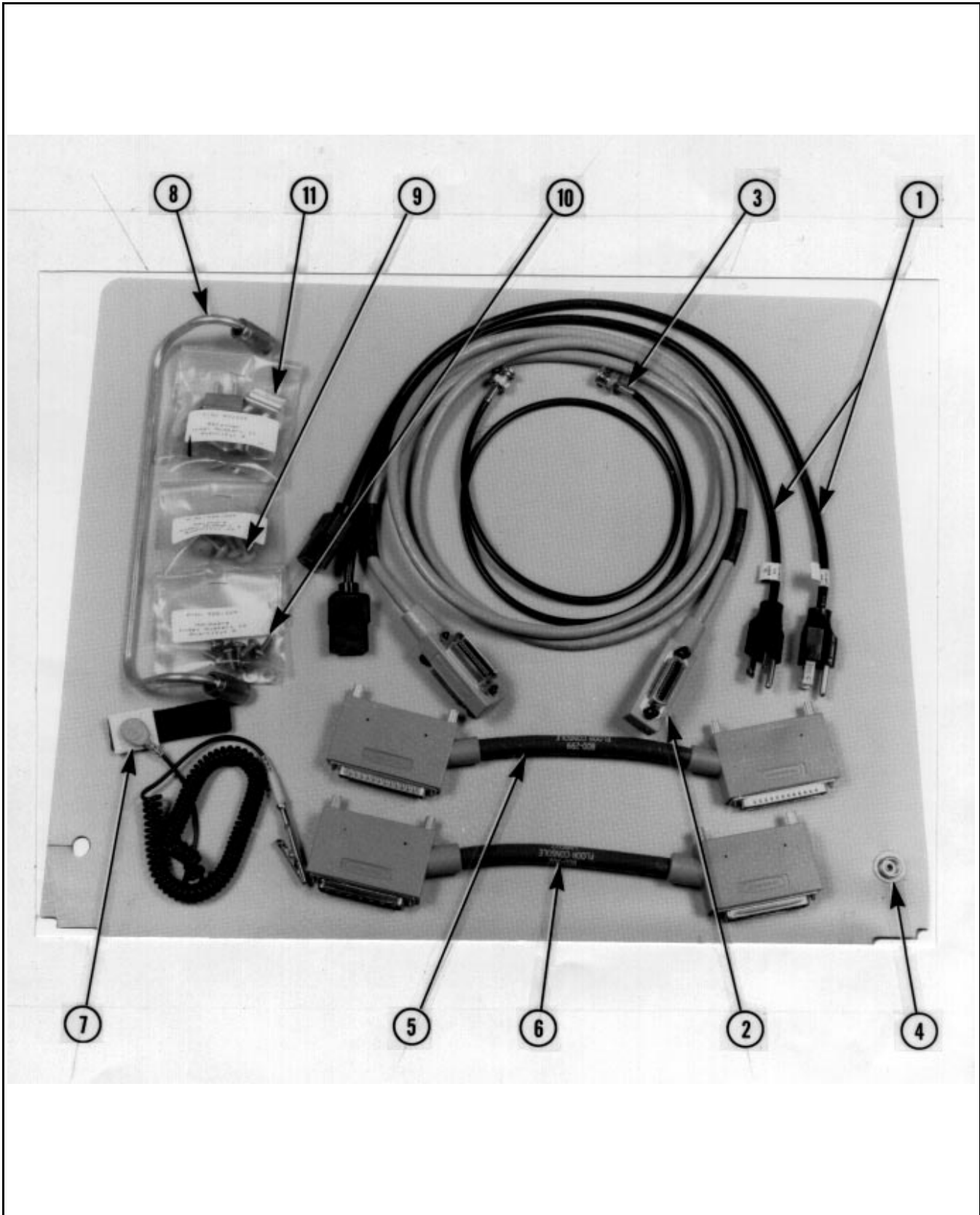

Figure 2-1. Accessory Parts Used for Assembling the 360PS20A System (1 of 2)

Table 2-1. List of Accessory Parts, 360PS20A System (1 of 2)

Index Number	Description	Part Number	Quantity
①	Power cord for connecting the network analyzer and the frequency synthesizer to the ac bus.	800-279	2
②	Interconnect cable with GPIB connectors on each end, 1 meter long. Used to connect the network analyzer SOURCE CONTROL port to the frequency synthesizer IEEE-488 GPIB port.	2100-1	1
③	Signal cable with BNC female connectors on each end, 3 feet long. Used to connect the network analyzer 10MHz REF OUT to the frequency synthesizer 10 MHz REF INPUT.	800-124	1
④	Mat for dissipating static electricity.	2000-204	1
⑤	Interface cable to connect between the CONTROL ports on the network analyzer and the test set.	800-393	1
⑥	Interface cable to connect between the SIGNAL ports on the network analyzer and the test set.	800-394	1
⑦	Strap and cord for connecting between the operator's wrist and the static dissipative mat.	783-163	1
⑧	RF semirigid cable between the frequency synthesizer RF OUTPUT and the test set RF INPUT.	C34429-1	1
⑨	Grey, decorative screws used to secure the network analyzer, the test set, the frequency synthesizer, and the auxiliary control module to the 360C1 system console.	900-609	16
⑩	Writing shelf assembly parts, consisting of the following: Washer, #10, Split Lk Screw, Pan Hd, 10-32x0.5 inch, Phillips. Nut, Kep, 10-32x0.375 inch Washer, #10, Flat, 0.375 inch	900-396 900-223 900-338 900-352	8 8 2 2
⑪	Bracket-clip assembly parts, consisting of the following: Bracket-clip used to retain the network analyzer, the test set, the frequency synthesizer, and the auxiliary control module to the rear of their individual support brackets. Nut, Kep, 8-32x0.343 inch Washer, #8, Flat, 0.375 inch	A32339 900-336 900-351	8 16 16

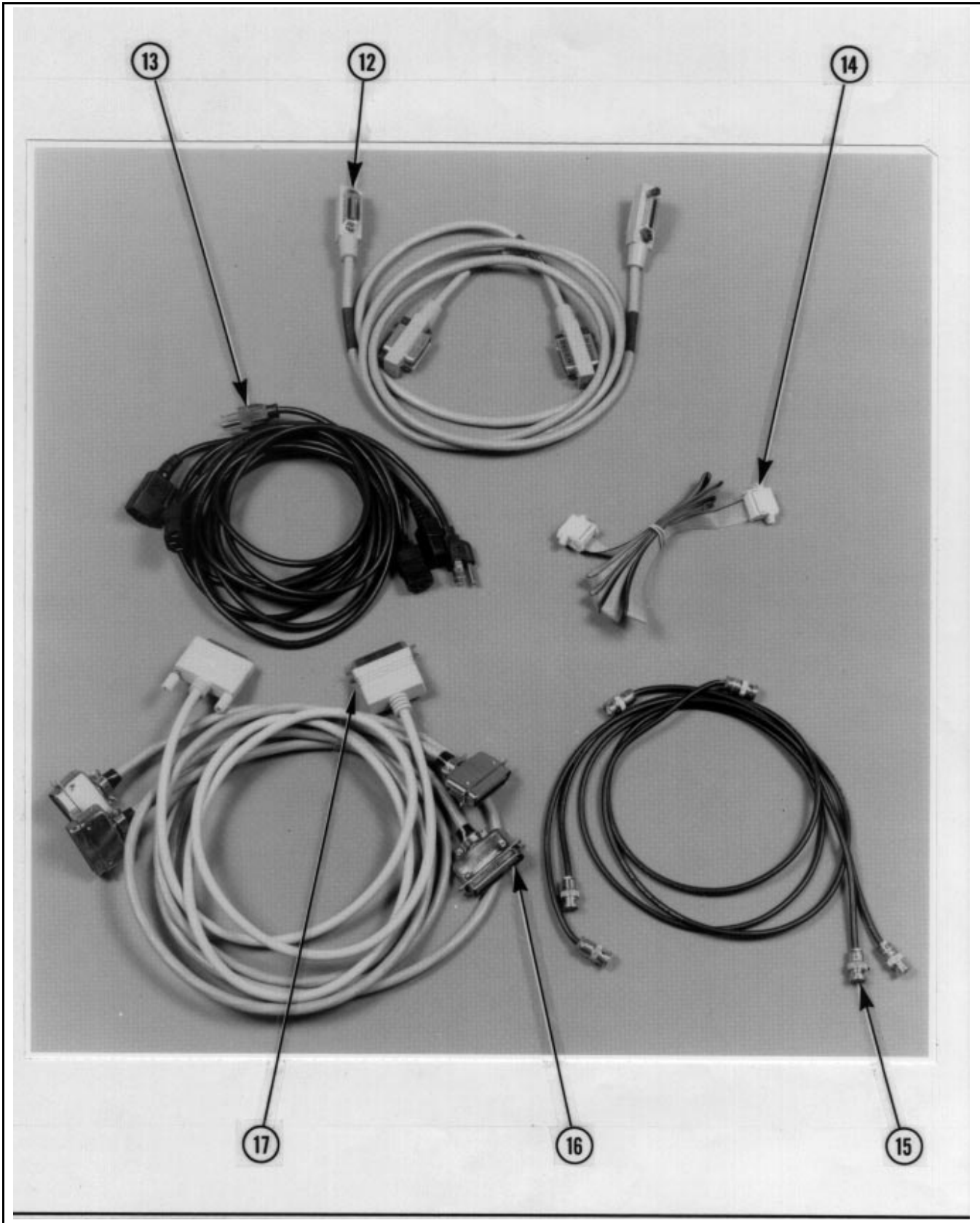
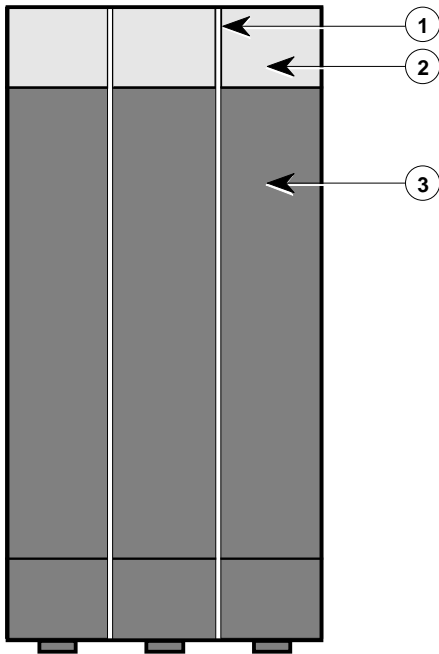

Figure 2-1. Accessory Parts Used for Assembling the 360PS20A System (2 of 2)

Table 2-1. List of Accessory Parts, 360PS20A System (2 of 2)

Index Number	Description	Part Number	Quantity
12	Interconnect cable with GPIB connectors on each end, 2 meters long. Used to connect the network analyzer 360 GPIB port to the computer/controller GPIB port and to connect the network analyzer 360 GPIB port to the auxiliary control module IEEE-488 STD GPIB port.	2100-2	2
13	Power cords for connecting the computer/controller and auxiliary control module to the ac bus.	800-119	2
14	Power cable assembly for connecting between the auxiliary control module ACM INTERFACE port and the test set POWER DIST SUPPLY port.	803-49	1
15	Signal cable with BNC female connectors on each end, 3 feet long. Used to connect between the frequency synthesizer 10 MHz REF OUT and the auxiliary control module 10 MHz IN, to connect between the pulse generator A□B port and the test set STIMULUS INPUT port, and to connect between the pulse generator C□D port and the test set PROFILE INPUT port.	800-124	3
16	Interconnect cable with parallel (Centronics) connectors at each end. Used to connect between the network analyzer PRINTER OUT port and the printer buffer CH.B port and between the printer buffer PRT port and the printer interface port.	2225-1	2
17	Interconnect cable with parallel (Centronics) connector at one end and a male 25-pin, D subminiature connector at the other end. Used to connect between the printer buffer CH.A port and the computer/controller printer port.	2225-6	1
Not Shown	Termination, 50Ω. Used for the test set high power termination. Connected to the test set HI PWR TERM port.	1015-18	1
Not Shown	Termination, 50Ω. Used for the termination of unused pulse generator output ports. Connected to the A□B and C□D ports of the pulse generator.	1015-19	2
Not Shown	Menu Strip. Used on the computer/controller keyboard to identify dedicated function keys during pulsed measurements.	B37864	1

Step 1



Remove the 360C1 system console from its shipping container, as follows:

- Cut the bands ①.
- Lift off the top ②.
- Remove the cardboard sleeve ③ by pulling straight up and away.
- Remove the packing materials.
- Remove the writing surface from atop the console and set it aside. You will be directed to complete its assembly in a later step.

Step 2

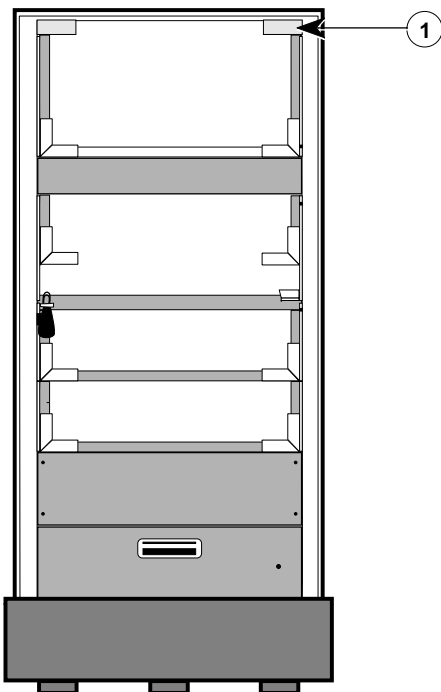

Remove the 360C1 system console from the shipping pallet, as follows:

- Insert two 4-to-6 foot lengths of 2x4-inch lumber through the top opening in the console ①.
- With a person stationed on the front side and another on the back side, use the 2x4's to lift the console off and away from the pallet.

Alternate Procedure

- Tilt the console on its back, being careful not to scratch the paint. Do not bend the bottom feet.
- Remove the pallet.

Figure 2-2. Unpacking and Assembling the 360PS20A System (1 of 7)

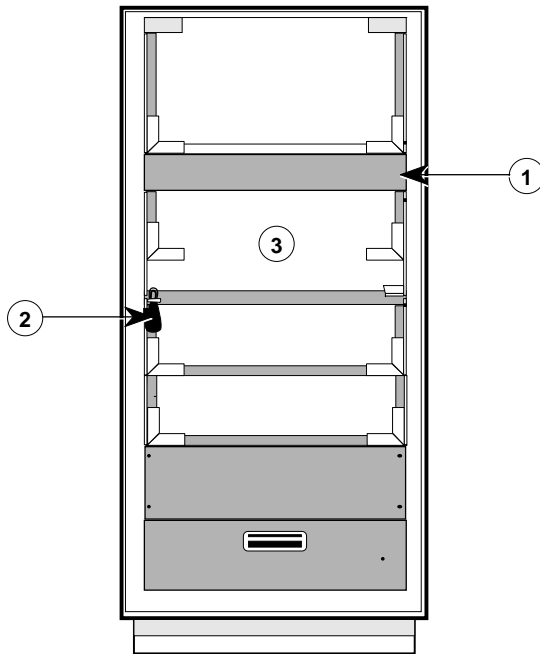
Step 3

Prepare the front of the system console for installation of the equipment, as follows:

- Remove the drawer retaining bracket ①.
- Cut the tie wrap from the Wrist Strap/Table Mat Ground Port ②, bring it out through the opening above the small panel ③, and let it hang free out of the way.

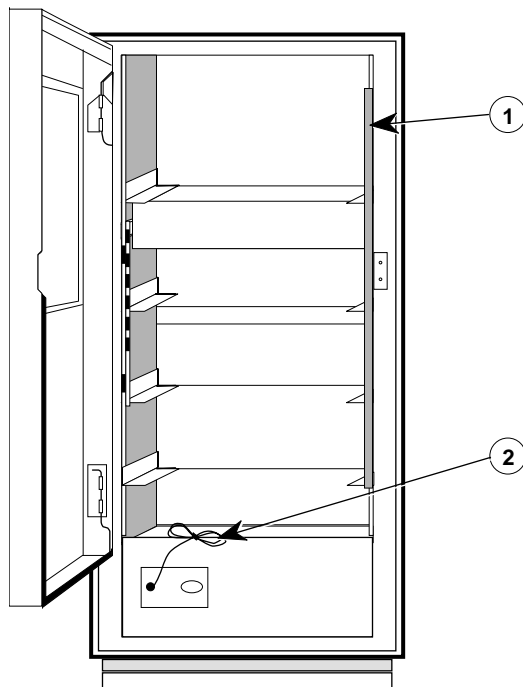
Step 4

Prepare the rear of the system console for installation of the equipment, as follows:

- Open the rear door, cut the tie wraps from the writing-surface rails ①, and remove the rails from the console.
- Cut the tie wrap from the Line Cord ②, and uncoil the cord.

Figure 2-2. Unpacking and Assembling the 360PS20A System (2 of 7)

Step 5

Prepare the Writing Surface as follows:

- Attach the two rails as shown, using the 10/32 x 1-inch screws and #10 lockwashers supplied in the attaching-parts kit.

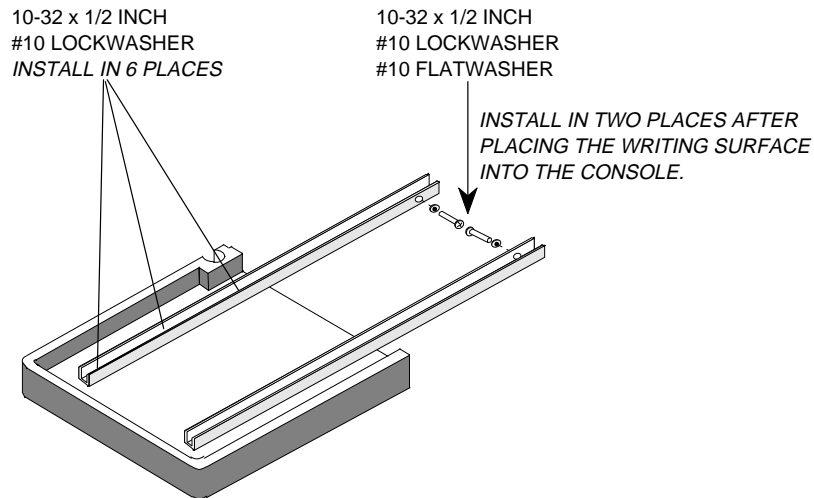

Step 6

Unpack the 360C4 computer console and assemble it following the instructions in the shipping container.

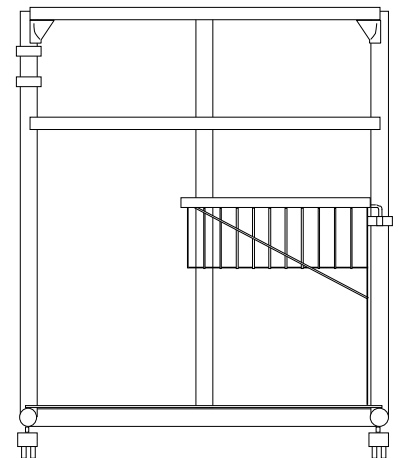

Figure 2-2. Unpacking and Assembling the 360PS20A System (3 of 7)

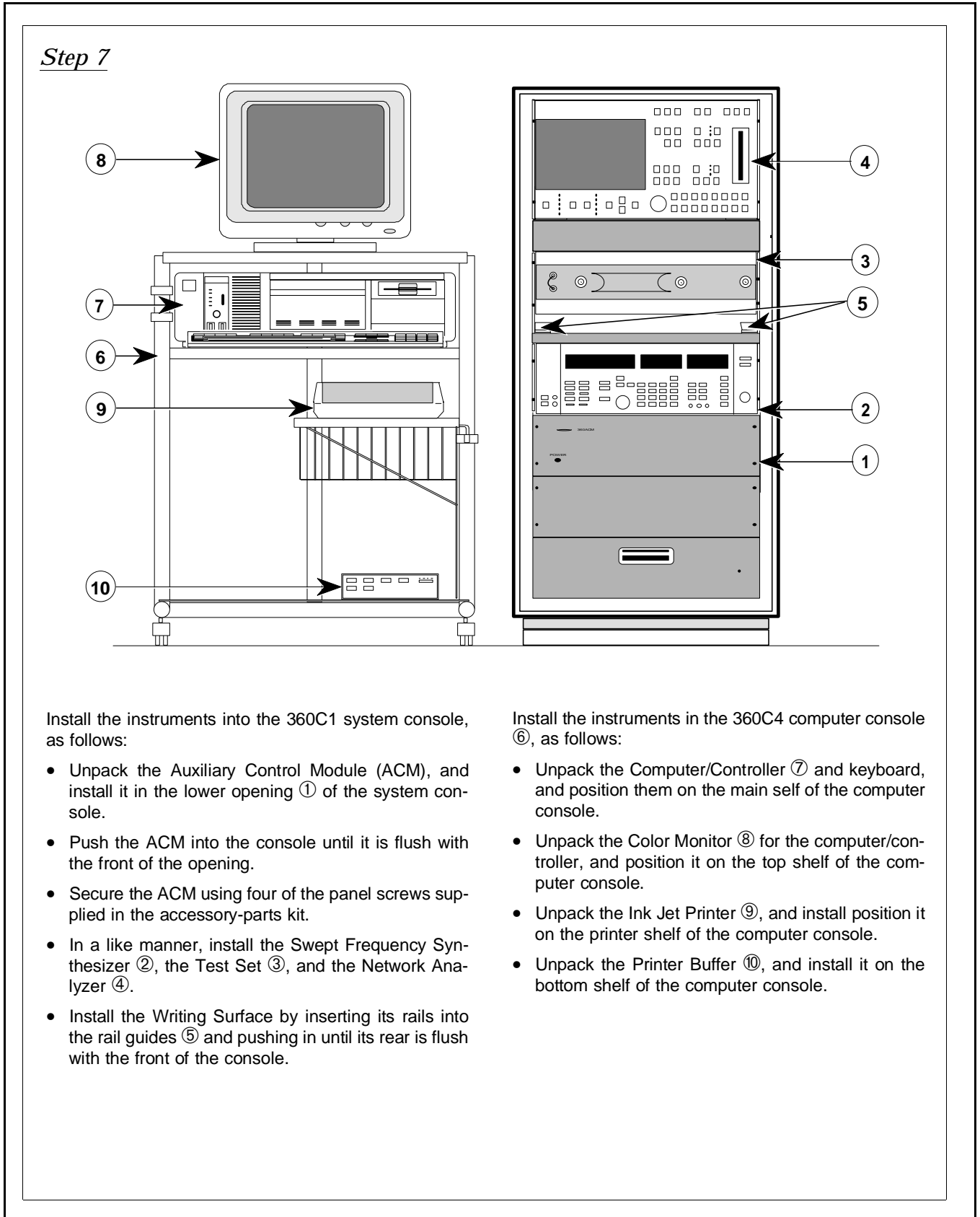

Figure 2-2. Unpacking and Assembling the 360PS20A System (4 of 7)

Step 8

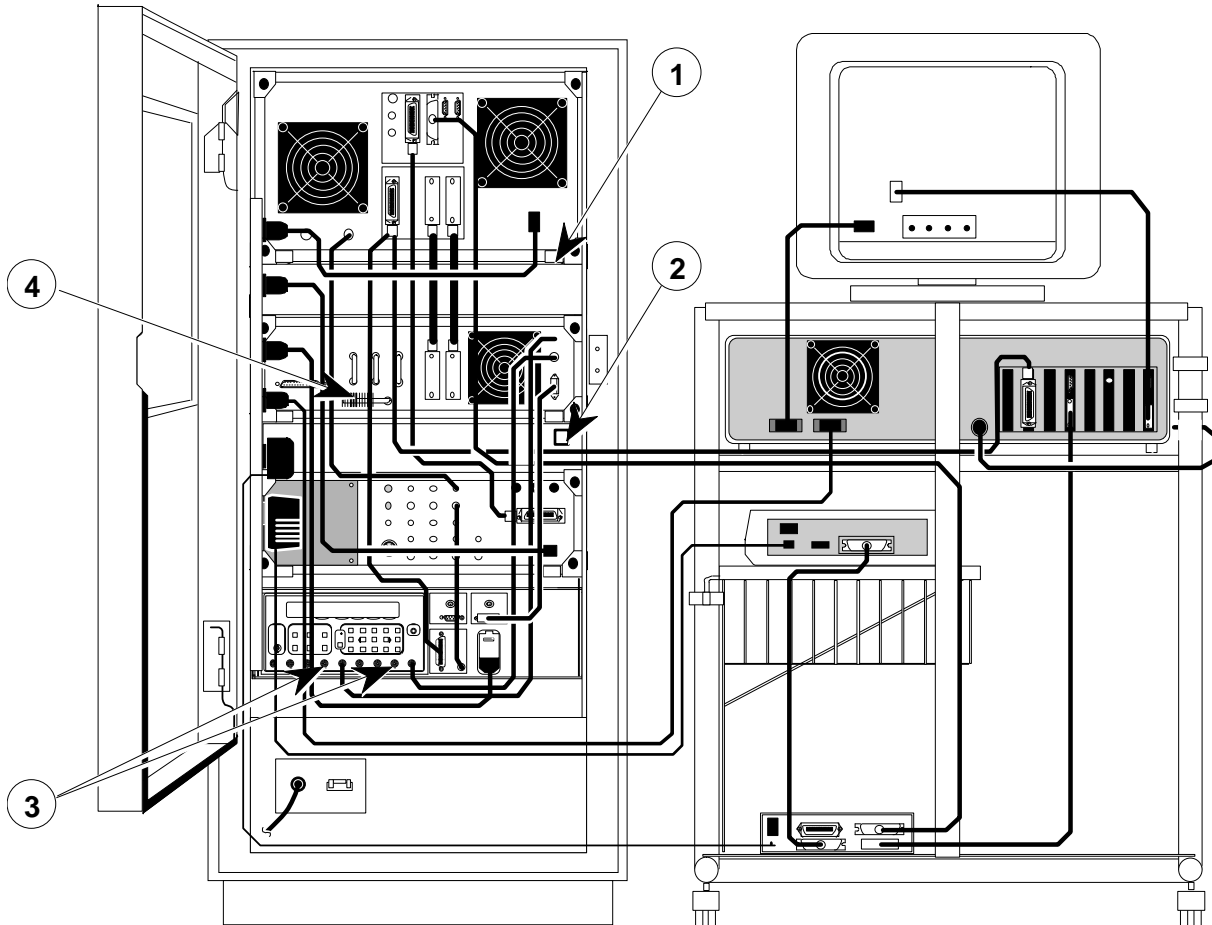

Figure 2-2. Unpacking and Assembling the 360PS20A System (5 of 7)

Step 8 (cont.)

Secure the instruments, as follows:

- Install the Retainer Clips ① on the rear of the Support Brackets (Detail A). Secure the network analyzer, the test set, the frequency synthesizer, and the auxiliary control module. Use 8/32 kep nuts and #8 flat washers.
- Secure the Writing Surface rails to the tapped hole in each rail guide ②. Use two 10/32 x 1/2-inch screws and #10 split-lockwashers from the accessory parts kit.

DETAIL A

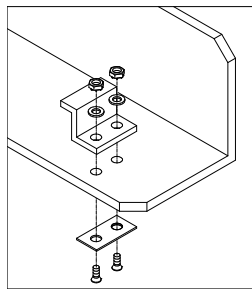

Install terminations on the instruments, as follows:

- Connect the two 50Ω BNC terminations ③, one to the A□□B port and one to the C□□D port on the pulse generator.
- Connect the 50Ω high power termination ④ to the HI PWR TERM port of the test set.

Install the interconnecting cables, as follows:

- Connect the Control cable (P/N 800-299) between the network analyzer CONTROL port and the test set CONTROL port.
- Connect the Signal cable (P/N 800-302) between the network analyzer SIGNAL port and the test set SIGNAL port.
- Connect a 1 m GPIB cable (the System Bus) between the network analyzer SOURCE CONTROL port and the frequency synthesizer IEEE-488 GPIB port.
- Connect a coaxial cable between the network analyzer 10MHz REF OUT port and the frequency synthesizer 10 MHz REF INPUT port.
- Connect a coaxial cable between the frequency synthesizer 10 MHz REF OUTPUT port and the auxiliary control module 10 MHz IN port. (This connects to the pulse generator 10 MHz EXT INPUT.)
- Connect a coaxial cable between the pulse generator A□□B port and the test set STIMULUS INPUT port.
- Connect a coaxial cable between the pulse generator C□□D port and the test set PROFILE INPUT port.
- Connect the power cable between the auxiliary control module ACM INTERFACE port and the test set POWER DIST SUPPLY port.

- Connect the computer monitor's power and signal cables to the appropriate ports on the computer/controller.
- Connect the keyboard cable to the keyboard port on the computer/controller.
- Connect a 2 m GPIB cable between the computer/controller PCII GPIB port and the network analyzer 360 GPIB port.

- Parallel connect a 2 m GPIB cable between the network analyzer 360 GPIB port and the auxiliary control module IEEE-488 STD GPIB port. (This connects to the pulse generator IEEE-488 STD. PORT.)
- Connect a printer cable having parallel (Centronics) connectors at each end between the network analyzer PRINTER port and the printer buffer CH B port.
- Connect a printer cable having parallel (Centronics) connectors at each end between the printer buffer PTR port and the printer PARALLEL INTERFACE port.
- Connect the printer cable having a male 25-pin, D subminiature connector at one end and a parallel (Centronics) connector at the other end between the computer/controller parallel port and the printer buffer CH A port.
- Connect the power cords for the computer/controller, network analyzer, frequency synthesizer, auxiliary control module, printer buffer, and printer to the power strip located in the system console.

CAUTION

The power cables for the printer and the printer buffer both have power modules and look the same but each one outputs a different voltage. The printer power module converts 115 Vac to 9 Vac; the printer buffer power module converts 115 Vac to 9 Vdc. Equipment damage can result if the wrong power cable is connected.

Figure 2-2. Unpacking and Assembling the 360PS20A System (6 of 7)

Step 9

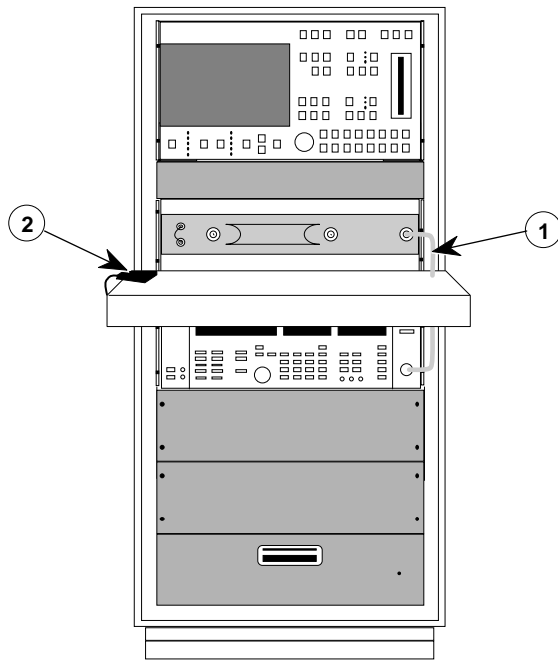

Complete the assembly, as follows:

- Install the semirigid RF output cable ① between the frequency synthesizer RF OUTPUT port and the test set RF INPUT port.
- Lay the static mat on the Writing Surface.
- Snap the Wrist Strap/Ground Port ② to the Static Mat.
- Plug the end of the Wrist Strap into the Wrist Strap/Ground Port. Cut the tie wrap and uncoil the cable.
- Check the line voltage setting on the rear of the network analyzer, the frequency synthesizer, the auxiliary control module, the pulse generator, and the computer/controller. If any setting differs from the voltage present in your area, refer to paragraph 2-4 for instructions.

Figure 2-2. Unpacking and Assembling the 360PS20A System (7 of 7)

2-4 CHANGING THE LINE VOLTAGE

The network analyzer, the frequency synthesizer, the computer/controller, and the auxiliary control module all have line voltage modules that let them operate at line voltages of 100-120 Vac and 220-240 Vac. Prior to leaving the factory, the instru-

ments are set to the proper line voltage for the area for which the system is destined. If these settings are incorrect, refer to Figure 2-3 for instructions on how to change the line voltage settings of all instruments.

<p>Change the line selection switch setting to the other value (110 or 220) as appropriate.</p> <p>Verify that the fuse is the correct value for the line voltage selected.</p>	 <p>LINE SELECTION</p>	<p>NOTE</p> <p>For line voltages lower than 90V (180V) or higher than 121V (242V), use a variac to bring the line voltage into the required range.</p>
Network Analyzer or Frequency Synthesizer		
<p>Change the line selection switch setting to the other value (115V or 230V) as appropriate.</p>		
Computer/Controller		
<p>To change the line voltage from that shown on the Line Voltage Selector Module, proceed as follows:</p> <ul style="list-style-type: none"> • Remove the power cord from the line voltage module. • Insert the blade of a small screwdriver into the slot at the top-center of the module, and pry open the cover. • Remove the voltage selector drum by pulling straight out. • Rotate the drum so that the desired line voltage marking faces out, then reinstall the drum. • Remove the fuse cartridge (identified with a white arrow and located beneath the voltage selector drum). • Check that the fuse installed is correct for the voltage selected: <ul style="list-style-type: none"> 100-120V, 5A Sloblow, 3AG 220-240V, 2.5A Sloblow, 3AG • Change the fuse, if necessary, and install the fuse cartridge. • Close the cover and reconnect the power cord. 	<p style="text-align: center;">LINE VOLTAGE SELECTOR MODULE</p>  <p>VOLTAGE SELECTOR DRUM</p> <p>FUSE CAVITY</p>	
Auxiliary Control Module		

Figure 2-3. Changing Line Voltage Settings for 360PS20A System Instruments

2-5 GPIB SETUP AND INTERCONNECTIONS

The computer/controller controls the operation of the 360PS20A system via the GPIB (IEE-488) interface bus. The following paragraphs provide information about GPIB interface connections, cable requirements, and addressing.

2-5.1 Interface Connector

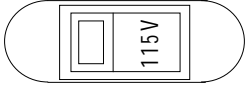
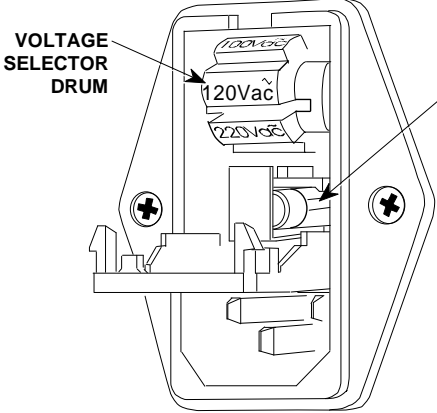
Interface between the computer/controller, the network analyzer, and the pulse generator on the GPIB is via 24-wire interface cables. These cables use connector shells having two connector faces. These double-faced connectors allow for the parallel connection of two or more cables to a single device.

2-5.2 Cable Length Restrictions

The GPIB system can accommodate up to 15 instruments at any one time. To achieve design performance on the bus, proper timing and voltage level relationships must be maintained. If either the cable length between separate instruments or the accumulated cable length between all instruments is too long, the data and control lines cannot be driven properly and the system may fail to perform. Cable length restrictions are as follows:

- No more than 15 instruments may be installed on the bus.
- Total cumulative cable length in meters may not exceed two times the number of bus instruments or 20 meters; whichever is less.

NOTE

For low EMI applications, the GPIB cable should be a fully shielded type, with well-grounded metal-shell connectors.

2-5.3 GPIB Interconnections

The only 360PS20A system GPIB interconnections are between the computer/controller, the network analyzer, and the pulse generator. The interconnections are via a standard GPIB cable. The WILTRON part numbers for GPIB cables are 2000-1, -2, or -4 (1, 2, or 4 meters in length).

2-5.4 GPIB Addresses

The computer/controller leaves the factory preset to GPIB address 0, the network analyzer to address 6, and the pulse generator to address 15. You can change the GPIB addresses of the network analyzer and pulse generator, if desired, as follows:

- a.** Set the new GPIB address for the network analyzer (refer to the 360 VNA Operation Manual for procedures) or the pulse generator (refer to Section 4 of this manual for procedures).
- b.** You now need to change the GPIB software configuration in the computer/controller.
 1. Reboot the computer/controller.
 2. At the DOS prompt, type: `IBCONF`, then press `<ENTER>`. (The Title Screen is displayed.)
 3. Press `<ENTER>` to display the Device Map.
 - (a) If you changed the GPIB address of the network analyzer, select DEV6. A Device Characteristics display for DEV6 is displayed. Enter the new address as the Primary GPIB Address, then press function key, F9 to return to the Device Map display.
 - (b) If you changed the GPIB address of the pulse generator, select DEV15. A Device Characteristics display for DEV15 is displayed. Enter the new address as the Primary GPIB Address, then press function key, F9 to return to the Device Map display.
 4. When you are finished, press function key, F9 to exit the program.
 5. Reboot your computer. This installs the new software configuration.

2-6 PREPARATION FOR STORAGE AND/OR SHIPMENT

Paragraphs 2-6.1 and 2-6.2 give instructions for preparing the VNA system for storage or shipment.

2-6.1 Preparation for Storage

Preparing the VNA system for storage consists of cleaning the units, packing the inside with moisture-absorbing desiccant crystals, and storing them in a temperature environment that is maintained between -40°C and $+70^{\circ}\text{C}$.

2-6.2 Preparation for Shipment

To provide maximum protection against damage in transit, the VNA system instruments should be re-packaged in their original shipping containers. If these containers are no longer available and the instruments are being returned to WILTRON for repair, advise WILTRON Customer Service; they will send new shipping containers free of charge. In the event neither of these two options is possible, instructions for packaging and shipment are given below.

- a. **Use a Suitable Container.** Obtain a corrugated cardboard carton with a 275-pound test strength. This carton should have inside dimensions no less than six inches larger than the instrument dimensions to allow for cushioning.
- b. **Protect the Instrument.** Surround the instrument with polyethylene sheeting to protect the finish.
- c. **Cushion the Instrument.** Cushion the instrument on all sides by tightly packing dunnage or urethane foam between the carton and the instrument. Provide at least three inches of dunnage on all sides.
- d. **Seal the Container.** Seal the carton by using either shipping tape or an industrial stapler.
- e. **Address the Container.** If the instrument is being returned for service, mark the address of the appropriate WILTRON service center (Table 2-2) and your return address on the carton in one or more prominent locations.

Table 2-2. WILTRON Service Centers

UNITED STATES

WILTRON COMPANY
490 Jarvis Drive
Morgan Hill, CA 95037-2089
Telephone: (408) 778-2000
Telex: 285227 WILTRON MH
FAX: 408-778-0239

ANRITSU WILTRON SALES COMPANY
685 Jarvis Drive
Morgan Hill, CA 95037-2809
Telephone: (408) 776-8300
FAX: 408-776-1744

ANRITSU WILTRON SALES COMPANY
15 Thomton Road
Oakland, NJ 07436
Telephone: (201) 337-1111
FAX: 201-337-1033

AUSTRALIA

WILTRON PTY. LTD.
1/410 Church Street
North Parramatta
NSW 2151 Australia
Telephone: (02) 6308166
Fax: (02) 6836997

BRAZIL

ANRITSU ELECTRONICA S.A.
Av. Passos, 91-Sobrelhojas 203/205-Centro
20.051 Rio de Janeiro-RJ
Telephone: (011) 2853091
Telex: 11 33532 ANBR BR
Fax: (011) 2886940

CANADA

WILTRON INSTRUMENTS LTD.
215 Stafford Road, Unit 102
Nepean, Ontario K2H 9C1
Telephone: (613) 726-8800
FAX: (613) 820-9525

CHINA

WILTRON BEIJING SERVICE CENTER
Da Hua Radio Instrument Factory
P.O. Box 2452, Beijing
Telephone: (01) 277-681 Ext. 460
FAX: (01) 201-7108

FRANCE

WILTRON S.A.
9 Avenue du Quebec
Zone de Courtaboeuf
91951 Les Ulis Cedex
Telephone: (01) 64-46-65-46
FAX: (01) 64-46-10-65

INDIA

ACCUTROL SYSTEMS PRIVATE LIMITED
Nirmal, 15th Floor
Narimen Point
Bombay 400 021
Telephone: 011-91-22-202-2220
: 011-91-22-204-7187
FAX: 011-91-22-202-9403

ISRAEL

TECH-CENT, LTD
7A, Pinhas Rosen Street
Tel-Aviv 69356
Telephone: (03) 481958
FAX: (03) 481958

ITALY

WILTRON Sp.A
Roma Office
Via E. Vittorini, 129
00144 Roma EUR
Telephone: (06) 5005171
FAX: (06) 5005273

JAPAN

ANRITSU CORPORATION
1800 Onna Atsugi-shi
Kanagawa-Prf. 243 Japan
Telephone: 0462-23-1111
FAX: 0462-25-8379

KOREA

WILTRON CORPORATION
1201 Sinsong Bldg. 12F,
25-4 Yeoeuido-Dong
Youngdeungpo-ku, Seoul
Telephone: (02) 785-6407
FAX: (02) 784-6409

SWEDEN

WILTRON AB
Box 247
S-127 25 Skarholmen
Telephone: (08) 7405840
Telex: (854) 8135089
FAX: (08) 7109960

TAIWAN

WILTRON CO., LTD.
8F, No. 96, Section 3
Chien Kuo N. Road
Taipei, Taiwan, R.O.C.
Telephone: (02) 515-6050
FAX: (02) 509-5519

UNITED KINGDOM

ANRITSU EUROPE LTD.
Capability Green
Luton, Bedfordshire
LU1 3LU, England
Telephone: (0582) 418853
Telex: (851) 826750
FAX: (011) 58231303

WEST GERMANY

WILTRON GmbH
Rudolf Diesel Str 17
8031 Gilching
Telephone: (08105) 8055
Telex: (841) 528523
FAX: (08105) 1700

SECTION III OPERATION

CONTENTS

3-1	INTRODUCTION	3-5
3-2	360PS20A PULSED/CW VNA SYSTEM, GENERAL DESCRIPTION	3-5
3-2.1	Swept Frequency Synthesizer	3-5
3-2.2	Test Set	3-6
3-2.3	Pulse Generator	3-7
3-2.4	Computer/Controller	3-7
3-2.5	Network Analyzer	3-7
3-2.6	Auxiliary Control Module	3-7
3-3	INTRODUCTION TO PULSED MEASUREMENTS . . .	3-8
3-3.1	The Pulse Environment	3-8
3-3.2	The Pulse Spectra	3-8
3-3.3	Pulse Profiling	3-8
3-4	THE PULSED MEASUREMENT PROCESS, GENERAL DESCRIPTION	3-9
3-4.1	The Pulse Application Program	3-9
3-4.2	The Stimulus and Profile Pulses	3-9
3-4.3	System Timing	3-9
3-4.4	Program Operation	3-9
3-5	SYSTEM START UP	3-13
3-5.1	360 VNA Power Up	3-13
3-5.2	Pulse Generator Power Up	3-13
3-5.3	Computer/Controller Power Up	3-14
3-5.4	Print Buffer and Printer Power Up	3-14
3-5.5	Loading the Program	3-15
3-6	MAKING PULSED MEASUREMENTS	3-16
3-6.1	Menus and Data Displays	3-16
3-6.2	Function Keys	3-17
3-6.3	Program Title Screen	3-18
3-6.4	Main Menu Selections	3-19
3-6.5	Setting Pulse Parameters	3-21
3-6.6	Configuring the Pulse Modulators	3-28

3-6.7	Calibrating the 360 VNA System	3-30
3-6.8	Performing a Pulse Profile Measurement	3-31
3-6.9	Displaying the Measurement Data	3-32
3-6.10	Display Enhancements	3-33
3-6.11	Setting the Data Display Scale Factors	3-34
3-6.12	Using Trace Memory	3-36
3-6.13	Selecting S-Parameters for Display	3-38
3-6.14	Selecting a Data Display Graph Type	3-40
3-6.15	Displaying a Marker	3-41
3-6.16	Printing Out Measurement Data	3-43
3-7	FILE UTILITIES	3-48
3-7.1	File Types	3-48
3-7.2	File Storage	3-48
3-7.3	Menu Item/Option Selection and Data Entry	3-48
3-7.4	File Utility Menu	3-49
3-7.5	Listing the Files	3-50
3-7.6	Saving Calibration, Setup, and Measurement Data Files	3-51
3-7.7	Recalling Calibration, Setup, and Measurement Files	3-52
3-7.8	Deleting Calibration, Setup, and Measurement Files	3-53
3-7.9	Copying Calibration, Setup, and Measurement Files	3-54
3-7.10	Renaming Calibration, Setup, and Measurement Files	3-55
3-8	ERROR AND WARNING MESSAGES	3-56
3-8.1	Error Messages	3-56
3-8.2	Warning Messages	3-56

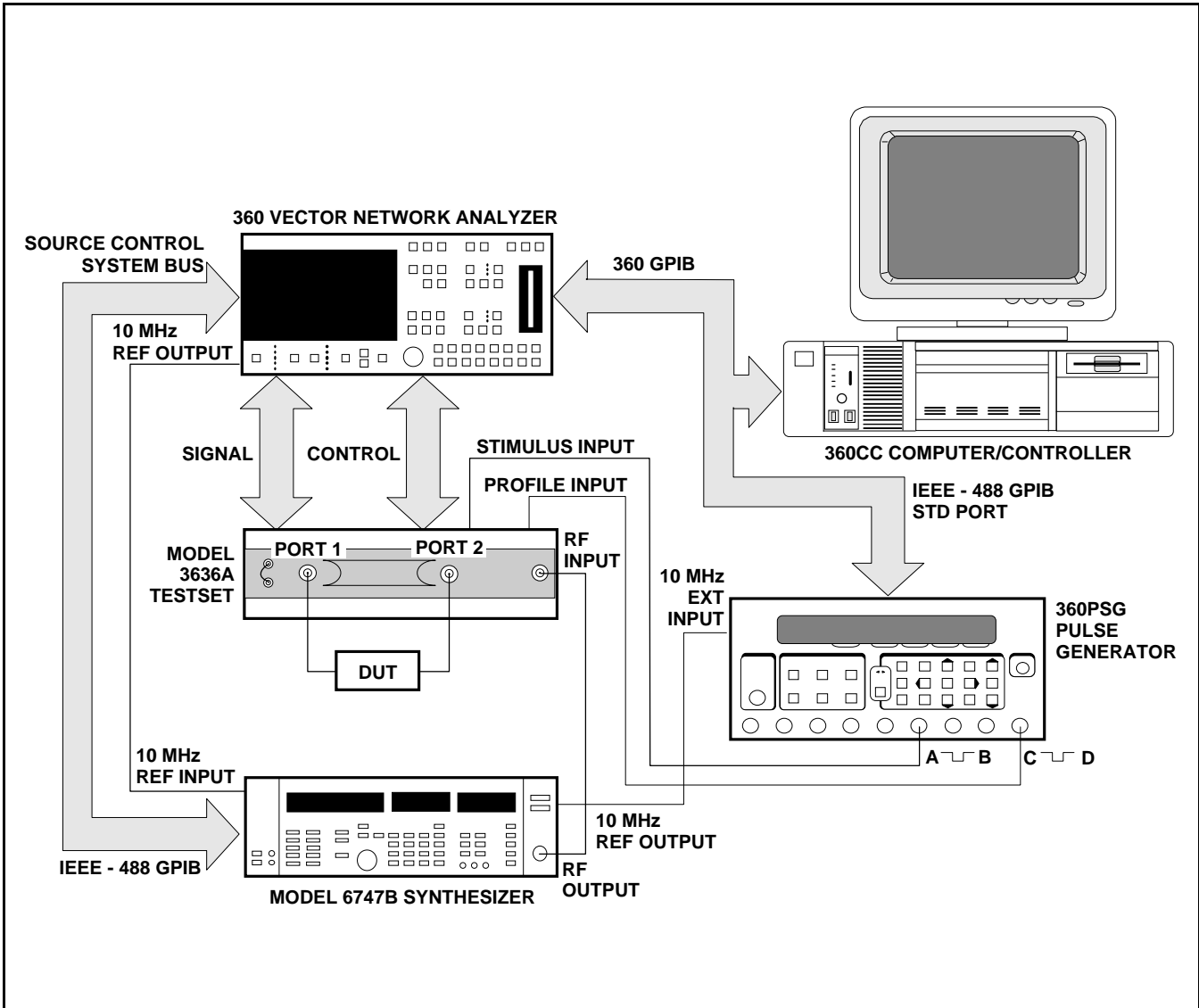

Figure 3-1. The Model 360PS20A Pulsed/CW Vector Network Analyzer System

SECTION III OPERATION

3-1 INTRODUCTION

This section contains the step-by-step instructions for starting up the 360PS20A Pulsed/CW VNA system and for making pulse profile measurements. It also contains a general description of the system and the pulsed measurement process. Included in this section are the error and warning messages that may be encountered during pulsed measurements and the operator action necessary to clear each error condition.

NOTE

Operating instructions for 360 VNA system setup, calibration, CW measurements, and data display are not covered in this manual. Refer to the 360 VNA Operation Manual (P/N 10410-00104) for this information.

3-2 360PS20A PULSED/CW VNA SYSTEM, GENERAL DESCRIPTION

The Model 360PS20A Pulsed/CW VNA system measures the magnitude and phase performance of devices during pulsed or CW RF stimulus. The system characterizes a device-under-test (DUT) by comparing the relative magnitude and phase changes between the signal incident to the DUT and the reflected or transmitted signal from the DUT. The characteristics derived from this comparison are called S-Parameters. Depending on the calibration performed and the correction applied, up to four S-Parameters can be measured. They are:

- S₁₁ = Forward Reflection
- S₂₁ = Forward Transmission
- S₁₂ = Reverse Transmission
- S₂₂ = Reverse Reflection

The 360PS20A system performs these full reversing, error-corrected S-Parameter measurements in both pulsed and CW modes. The S-Parameters are displayed graphically on a color display. The system provides display and analysis features—such as scaling, marker readout, and trace memory—that can be applied to the measurement data display. In addition, the measurement data can be output to a printer.

The 360PS20A system is capable of performing pulsed measurements in two modes. The pulsed measurement modes are:

- A sweep of pulse profiling positions for a CW frequency. This is referred to as the pulse profile measurement mode.
- A fixed pulse profiling position for either a frequency sweep or a single CW frequency. This is referred to as the fixed profile pulse measurement mode.

The measurement frequency range of the 360PS20A system is from 890 MHz to 20 GHz. Pulse profiling can be performed with pulse widths as narrow as 20 ns. The system test set can handle up to 20 Watts peak (10 Watts average) forward power and can make high power forward measurements.

The 360PS20A Pulsed/CW VNA system (Figure 3-1) consists of five main components and one auxiliary component:

- Swept Frequency Synthesizer
- Test Set
- Pulse Generator
- Computer/Controller
- Network Analyzer
- Auxiliary Control Module

3-2.1 Swept Frequency Synthesizer

The swept frequency synthesizer is the RF signal source for the 360PS20A system. It provides the stimulus signal to the DUT via the test set. The synthesizer is controlled by the network analyzer through the dedicated Source Control System bus. To assure coherent detection of test signals, the synthesizer is locked to the 10 MHz reference time base of the network analyzer. Frequency resolution during the CW mode of operation (receiver synthesizer/tracking mode) is 1 kHz; resolution during the pulsed mode of operation (Receiver set on mode) is 100 kHz.

Although the 360PS20A system comes equipped with a WILTRON Model 6747B swept frequency synthesizer, any WILTRON 6700B swept frequency

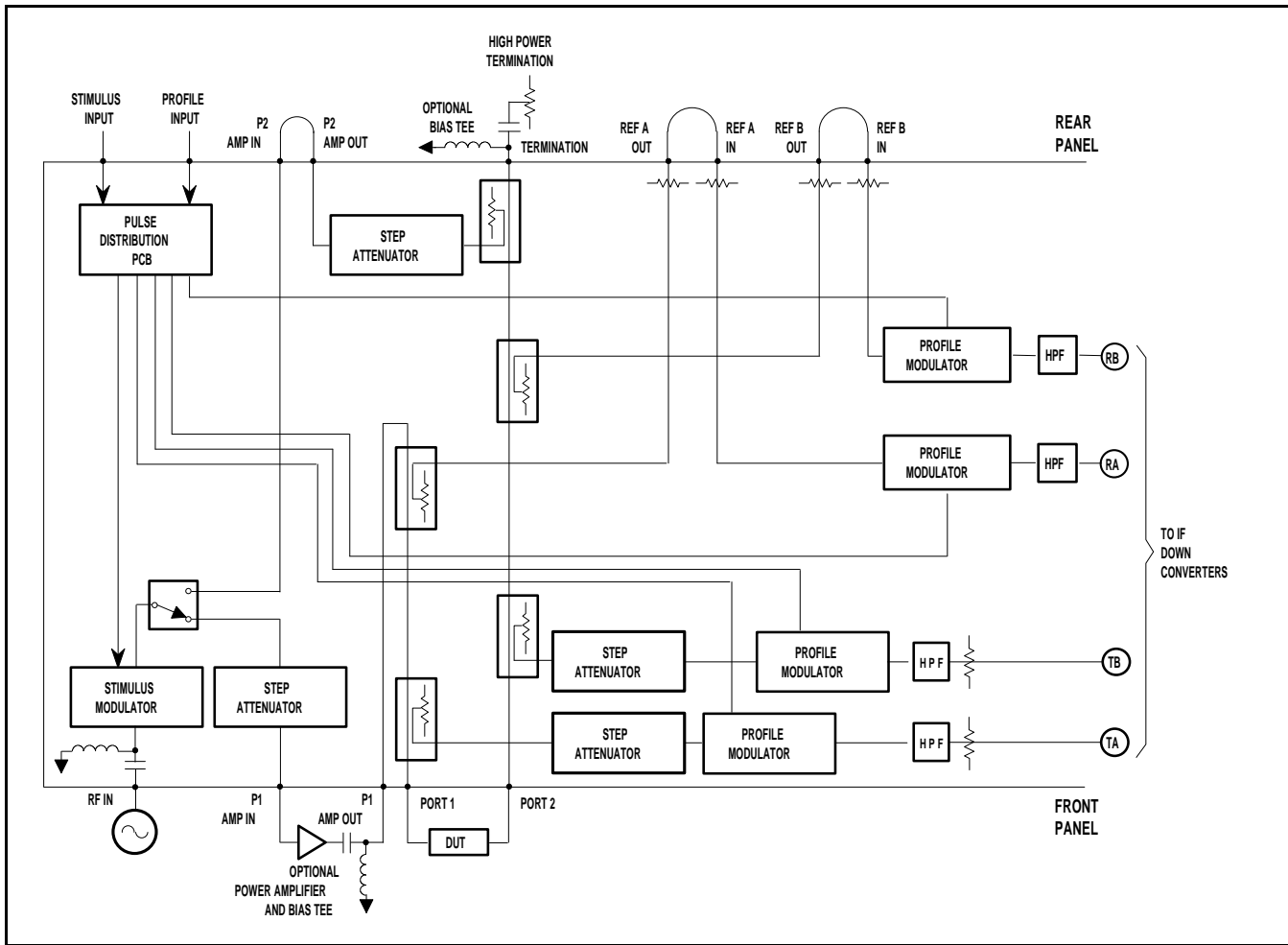

Figure 3-2. Model 3636A Pulsed/CW Test Set Block Diagram (RF Section)

synthesizer operating over the frequency range of 890 MHz to 20 GHz may be used.

3-2.2 Test Set

The test set contains the measurement components and the pulse modulators for the 360PS20A system. The test set, under control of the network analyzer, performs:

- Stimulus-RF-signal routing from the synthesizer to the DUT through one of the test ports (Port 1 or Port 2).
- Pulse modulation of the stimulus-, test-, and reference-RF-signals during the pulse measurement mode.
- Signal separation and down conversion (1st, 2nd, and 3rd IF) of the incident-, reflected-, and transmitted-RF-signals at Ports 1 and 2 into four IF signals (Test A, Reference A, Test B, and Reference B).

- Amplification of the IF signals.

Refer to Figure 3-2 for a block diagram of the RF section of the test set. The test set provides automatic signal reversing of the test ports enabling full S-parameter testing without the need to manually reverse the DUT. It has a stimulus modulator for creating the stimulus pulse and four profile modulators (one for each channel) for creating the profile window. The modulators are external triggered by stimulus and profile pulses from the system pulse generator.

The test set supports high power testing. It contains couplers and step attenuators capable of 20 Watts peak (10 Watts average) forward power. In addition, there are ports provided for the addition of external power amplifiers and high power terminations. An additional coupler in Port 2 allows high-power forward measurements and low-power reverse measurements. The frequency range of the test set is 890 MHz to 20 GHz.

3-2.3 Pulse Generator

The 360PS20A system pulse generator provides two pulses to the test set; one to the stimulus modulator and one to each profile modulator. These pulses trigger the modulators to create the stimulus pulse and the profile window. The pulses produced by the pulse generator are precisely controlled for pulse width, pulse delay, and pulse repetition frequency (PRF). The pulse generator is directly controlled by the computer/controller through the GPIB. For synchronization, it is locked to the network analyzer's 10 MHz reference time base via the frequency synthesizer. Its trigger source can be internal or external.

The 360PSG pulse generator operation and service manual is included in the Supplements section of this manual. In addition to operating and service information, it contains complete GPIB programming instructions.

3-2.4 Computer/Controller

The computer/controller provides overall control of the 360PS20A system. Control is implemented through menus that provide selections for measurement mode (pulsed or CW) and for setting the pulse parameters. The computer/controller directly controls the pulse generator at all times. It directly controls the network analyzer during pulse profile measurements. When system calibration, CW measurements, and fixed pulse profile measurements are being performed, the computer/controller indirectly controls the network analyzer by mainly monitoring operations. The computer/controller interfaces with the network analyzer and pulse generator via the GPIB.

In the pulse profile measurement mode, the computer/controller processes the magnitude and phase measurement data and displays the resulting S-Parameters graphically on its color display. Menus are provided for data display enhancement and control as well as hardcopy data output.

3-2.5 Network Analyzer

Network analyzer operation is determined by the operational mode in which it is placed by the computer/controller. For pulse profile measurements, it is placed in remote mode and receives its operating instructions and parameters from the computer/controller. For system calibration, CW measurements, and fixed pulse profile measurements, the computer/controller places the network analyzer in local mode, then monitors its operation.

When in local mode, the network analyzer is the controller, signal processor, and display unit for the system, operating virtually independent of the computer/controller (except for pulse parameter data required for the fixed pulse profile measurements). Its front panel controls provide menu selections for test functions, test parameters, measurement enhancements, and frequencies. The network analyzer analyzes the IF signals from the test set for phase and magnitude data. It displays the results of this analysis (measurement data) as well as test parameters and system status on its color display. The data presented on the display can be output to a printer or to the rear panel (external) GPIB interface.

In both local and remote modes, the network analyzer sends frequency, power, and sweep information to the synthesizer over the dedicated Source Control System bus. It controls test set functions through a dedicated digital bus via the CONTROL and SIGNAL cable assemblies.

3-2.6 Auxiliary Control Module

The auxiliary control module is a 360PS20A system auxiliary unit. It supplies -15 Vdc to the system test set and provides housing and primary power for the system pulse generator.

The 360ACM auxiliary control module maintenance manual is included in the Supplements section of this manual.

3-3 INTRODUCTION TO PULSED MEASUREMENTS

Pulsed measurements at microwave frequencies are used extensively in radar and electronic warfare equipment to characterize transmit and receive modules, pulsed amplifiers, and pulsed MMIC transceivers. Pulse measurements are also used in component testing in order to prevent thermal destruction during high power testing of semiconductor devices.

3-3.1 The Pulse Environment

The 360PS20A system is able to measure the pulse performance of coherent systems. That means that the pulse is generated by amplitude modulating a cosine or sine wave function (Figure 3-3). The pulse period is the time period measured between the start of one pulse and the start of the next pulse. This must be constant. Pulse period is sometimes called cycle time. The pulse repetition frequency (PRF) is the reciprocal of the pulse period. PRF is frequently referred to as pulse repetition rate (PRR). The duty cycle is defined as the pulse width (PW) divided by the pulse period. Duty cycle is often called duty factor.

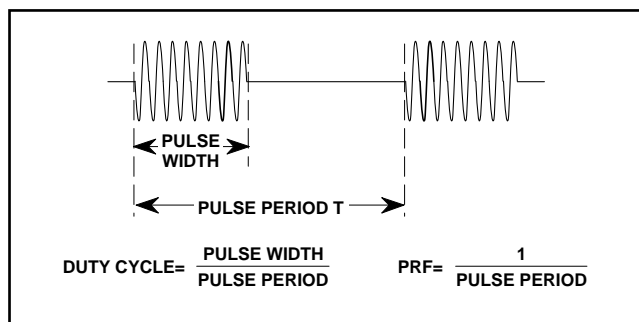

Figure 3-3. Pulsed RF Environment

3-3.2 The Pulse Spectra

Frequency spectra of an amplitude modulated coherent signal consists of line spectra (Figure 3-4). The main frequency component is at f_0 (the CW component of the pulse train). The carrier frequency and the other line spectra that form the $(\text{Sin } X)/X$ envelope, contain the information generated by modulation of the coherent signal. The line spectra are separated in frequency by $1/T$ which is the PRF. The zero points in the $(\text{Sin } X)/X$ envelope occur at multiples of $1/\tau_p$, the τ being the pulse width.

The 360PS20A performs pulse measurements by using the information associated with the central line spectra at f_0 . It isolates the line spectra at f_0 by the

use of a 500 Hz bandpass filter. This line spectra contains the average magnitude and phase of the RF signal in the profiling pulse. The power contained in this spectral line is related to the duty factor. At a duty factor of 100% (CW), all of the available power is in the spectral line.

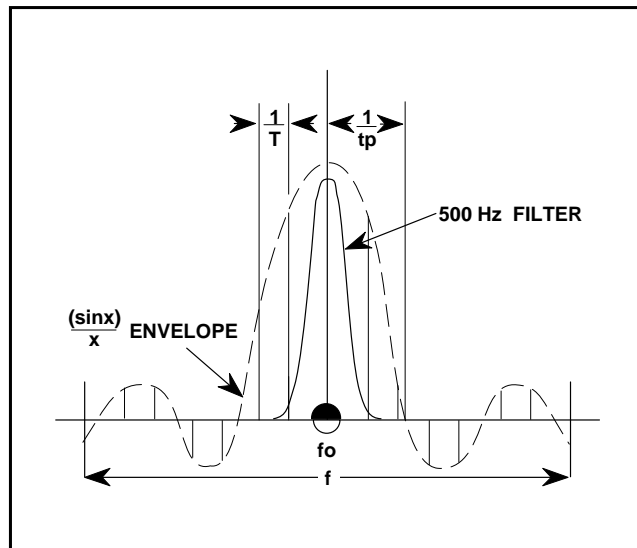

Figure 3-4. Pulse Spectra

3-3.3 Pulse Profiling

Pulse profiling is the measurement of magnitude and phase along a pulse (Figure 3-5). The 360PS20A system performs high resolution pulse profile measurements by using a profiling window that sweeps across the test pulse (the pulse response of the DUT to the stimulus-pulsed-RF-signal). The profiling window (pulse) is adjustable in width and can be set as narrow as 20 ns. The test pulse is reconstructed with the profiling samples. The magnitude and phase results are then displayed as a function of time. Examples of pulse profiling measurement data output are shown in Figures 3-28 through 3-30 (pages 3-45 thru 3-47).

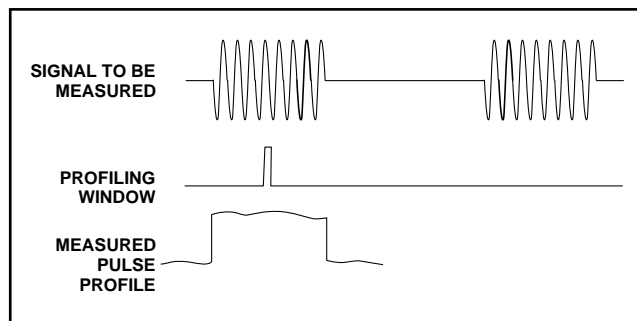

Figure 3-5. Pulse Profiling

3-4 THE PULSED MEASUREMENT PROCESS, GENERAL DESCRIPTION

The 360PS20A system measures the magnitude and phase performance of devices during pulsed RF stimulus. It can perform pulsed measurements in two modes: a pulse profile measurement mode and a fixed profile pulse measurement mode.

- Pulse Profile Measurement Mode – In the pulse profile measurement mode, the profile pulse sweeps across the test pulse (the pulse response of the DUT to the stimulus-pulsed-RF-signal). Performance data is measured at each pulse profile point. The computer/controller processes this measurement data, reconstructing the test pulse from the profiling samples, then outputs a data display of the performance data on the computer/controller's color display.
- Fixed Profile Pulse Measurement Mode – In the fixed profile pulse measurement mode, performance data is measured at a fixed profiling position for either a frequency sweep or a single CW frequency. Performance data is measured at each frequency data point. The network analyzer processes the measurement data and then outputs a data display of the performance data on the 360 VNA's color display.

3-4.1 The Pulse Application Program

The pulse application software program, resident in the computer/controller, controls the operation of the 360PS20A system during pulsed measurements. It provides menus that make it easy for you to setup the system and perform pulsed measurements. Once a pulsed profile measurement has been performed, it presents the measurement data graphically on a data display. It provides display control and enhancement menus to enable you to thoroughly analyze the measurement data. An output menu lets you print the measurement results in a graphical or tabular format. In addition to the menus, dedicated function keys are provided to permit easy access to the menus and menu items that are selected repetitively during operation.

3-4.2 The Stimulus and Profile Pulses

Pulsed measurement requires two pulses; a stimulus pulse and a profile pulse. The system pulse generator, under direct control of the pulse application software, provides two pulses to the test set. One pulse triggers the stimulus modulator to create the stimulus pulse; the other pulse triggers the four profile modulators (one for each channel) to create

the profile window. The pulse application software precisely controls the pulse parameters, which are the PRF, the pulse width of each pulse, the pulse delay, and the start and stop of the pulse profile. These parameters are set by the operator via pulse application program menus.

3-4.3 System Timing

Pulsed measurement requires synchronization of the stimulus and profile pulses. Synchronization is obtained by locking the pulse generator and the frequency synthesizer to the 10 MHz reference time base of the network analyzer and by using the leading edge of the pulse generator T0 output to initiate the 360PS20A system timing cycle. The stimulus pulse delay and profile pulse delay are established with respect to T0. The T0 output on the pulse generator can be used to trigger an external bias pulse before, during, or after the stimulus and/or profile pulse(s). Figure 3-6, on the following page, provides a pictorial representation of 360PS20A system pulsed measurement timing.

3-4.4 Program Operation

Once you have completed the system startup procedures and started the pulse application software, the program displays the main menu on the computer/controller's monitor and prompts you to select one of the following menu items:

```
SETUP  
CONFIGURE  
CALIBRATE  
MEASURE  
FILE UTILITY  
EXIT PROGRAM
```

The menu items listed represent the main operations involved in the pulsed measurement process plus the file utility component of the pulse application program. Although the program automatically positions the menu pointer to SETUP, there is no particular selection sequence to be followed. Each menu item can be selected independent of the others except for MEASURE, which can not be selected unless the measurement mode on the setup menu is set to pulse profile.

The menu items, SETUP, CONFIGURE, CALIBRATE, and MEASURE are also available using dedicated function keys. The main menu itself can also be accessed from other menus using a dedicated function key.

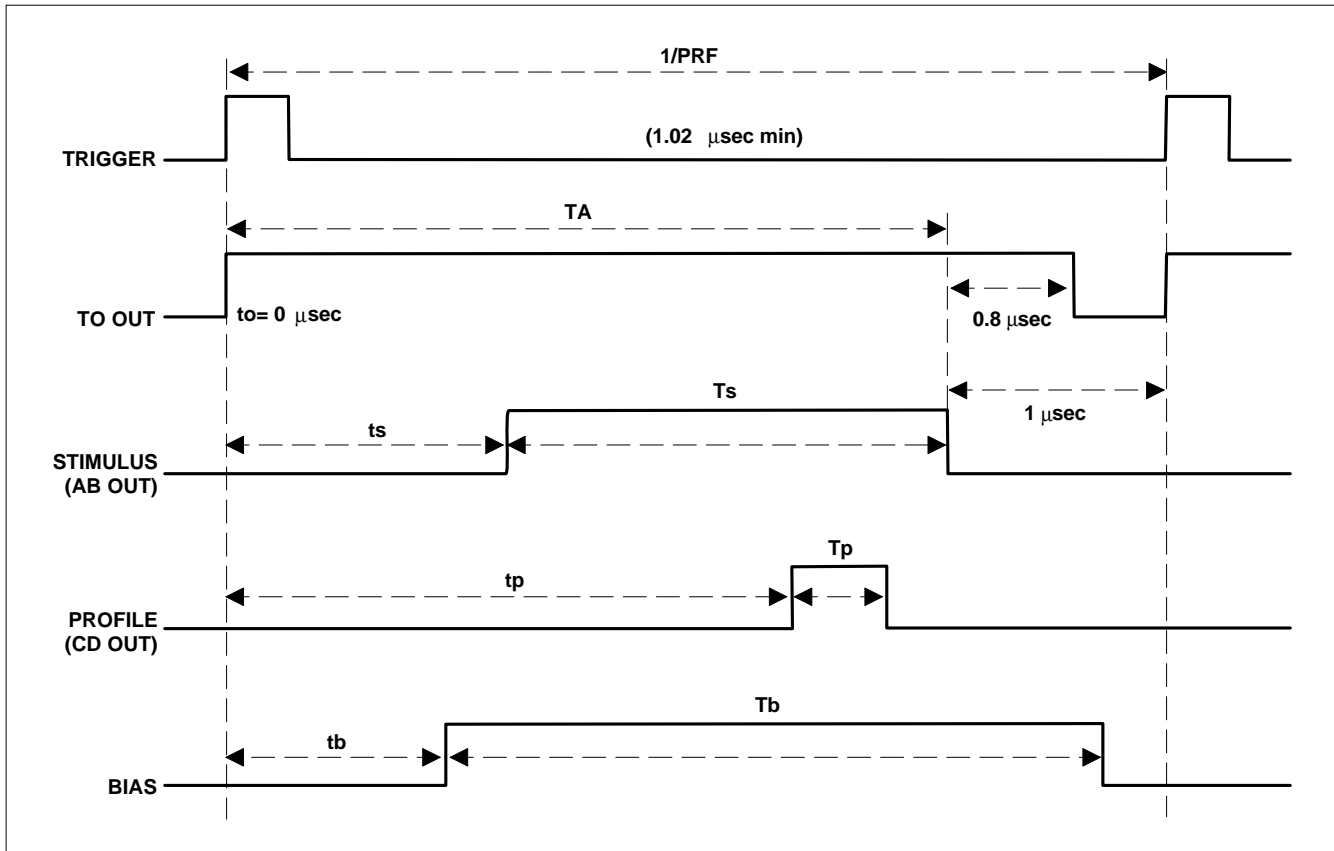

Figure 3-6. 360PS20A System Pulsed Measurement Timing Diagram

PRF limits: 1 kHz to 980 kHz (Pulse period of 1000 μsec to 1.02 μsec)

Each timing cycle is initiated by either an internal or external trigger. The T0 output goes high immediately (the external trigger to T0 output delay is: <0.085 μs).

The Stimulus pulse (ts) and Profile pulse (tp) delays are with respect to time t0 of the T0 output (for the pulse system, t0 = 0 μsec).

The T0 output goes low approximately 0.8 μsec after the falling edge of the stimulus pulse (Ts) or the profile pulse (Tp), whichever is greater.

TA is the time period within which the stimulus and profile pulses may be active (TA = 1/PRF - 1 μs).

Ts is the stimulus pulse width (pulse generator AB output); Tp is the profile pulse width (pulse generator CD output).

The T0 output of the pulse generator can be used to trigger a user's bias pulse. tb represents the delay of the external bias pulse that would be applied to the DUT. Tb is the external bias pulse.

a. Configuring the Pulse Modulators

When you select the main menu item, CONFIGURE, the program displays the configuration menu and prompts you to select the mode of operation of the stimulus pulse modulator and the individual profile pulse modulators located in the test set. In addition, you can also specify whether the system pulse generator trigger source is internal or external. The menu selections are:

- Stimulus Modulator (pulse or cw)
- Profile Modulators
 - Reference A channel (pulse or cw)
 - Reference B channel (pulse or cw)
 - Test A channel (pulse or cw)
 - Test B channel (pulse or cw)
- Pulse Generator Trigger Source (internal or external)

When you initially start up the program, or whenever you perform a system default, the configuration menu default settings are all modulators set to pulse and the pulse generator trigger source set to internal. The operational mode you set for the test set stimulus and profile pulse modulators on the configuration menu automatically changes the available selections for the setup menu items, stimulus mode and profile mode.

b. Setting the Pulse Parameters

Selecting the main menu item, SETUP, causes the program to display the setup menu. This menu lets you specify the type of measurement to be performed and lets you set all of the pulse parameters for a pulse profile or fixed profile pulse measurement. Additionally, if you set the measurement mode to pulse profile, you are prompted to set the pulse profile start and stop points, the data points, the CW frequency, and measurement averaging. The data entries and selections are:

- PRF (in kHz)
- Stimulus and Profile pulse width and pulse delay (in μ sec)
- Stimulus mode (pulse/cw - on or off)
- Profile mode (pulse/cw/user - on or off)
- Measurement Mode (pulse profile or fixed profile)

Pulse Profile Measurement Mode only:

- Pulse Profile Start and Stop points (in μ sec)
- Pulse Profile Step (in μ sec) or Number of Data Points
- CW Frequency (in GHz)

Averaging (on or off)

Number of Averages (when Averaging on)

When you initially start up the program, or whenever you perform a system default, the default pulse parameters are set. These parameters are shown in Figure 3-14 (page 3-21).

Fixed Profile Pulse Measurement – To perform a fixed profile pulse measurement, you set the measurement mode to fixed profile, input the values of the PRF and the stimulus and profile pulse widths and delays, and then set the stimulus and profile mode to pulse. The program displays the message – SEE 360 FOR MEASUREMENT DATA – on the setup menu display and places the VNA in local mode. You then perform the fixed profile pulse measurement on the 360 VNA. The VNA processes the measurement data and displays the performance results on its color display.

CW Measurement – To perform a CW measurement, you first need to go to the configuration menu and set the stimulus and profile modulators to cw. Then go to the setup menu and set the stimulus and profile mode to cw and the measurement mode to fixed profile. The program displays the message – SEE 360 FOR MEASUREMENT DATA – on the setup menu display and places the VNA in local mode. You then perform the CW measurements and display the performance results on the 360 VNA.

Pulse Profile Measurement – To perform a pulse profile measurement, you input the values for the PRF and the stimulus and profile pulse widths and delays, then set the stimulus and profile mode to pulse and the measurement mode to pulse profile. The program then prompts you to enter the additional pulse profile parameters and the CW frequency for the measurement. Once you have entered this data, you are ready to perform a pulse profile measurement.

c. Calibrating the System

When you select the main menu item, CALIBRATE, the program displays the calibrate menu and instructs you to perform a calibration on the 360 VNA. The program places the VNA in local mode to enable you to perform the calibration.

d. Performing a Pulse Profile Measurement

The main menu item, MEASURE, is only active when the measurement mode on the setup menu is set to pulse profile.

Selecting the main menu item, MEASURE, initiates the pulse measurement sequence and displays the pulse profile measurement display. This display is present on the computer/controller's monitor until the pulse profile measurement is completed.

e. Displaying the Measurement Data

Upon completion of a pulse profile measurement sequence, the program processes the measurement data, reconstructing the test pulse from the profile samples, then outputs a data display of the performance data on the computer/controller's color display. A menu of data display enhancement/control functions and hardcopy output is provided to assist you in analyzing the measurement results.

The data display enhancement/control functions are:

- Scale – lets you set the scale factors of scale reference, resolution, and reference line position for the measurement data display.
- Trace Memory – lets you store pulse profile S-Parameter measurement data in memory, view memory data, view both active measurement data and memory data simultaneously, and perform mathematical operations with the memory data and measurement data.
- S-Parameter – lets you select any of the measured S-Parameters for data display.
- Graph Type – lets you select the graph type for the data display of the selected S-Parameter.

- Marker – lets you display and control a single active marker.
- Output – lets you select the output format for the pulse profile measurement data printouts and specify the data header information on the printouts.

f. Using File Utilities

When you select FILE UTILITY on the main menu, the program displays the file utility menu and prompts you to perform one of the following file operations:

- Save system calibrations, setup configurations, or measurement data as files on either the computer/controller's hard disk or a floppy disk.
- Recall a saved file from the computer/controller's hard disk or a floppy disk.
- Perform a basic file operation such as delete, copy, rename, and list directory.

You can recall stored system calibrations, setup configurations, and measurement data at anytime during pulse application program operation.

g. Exiting the Program

When you select the main menu item, EXIT PROGRAM, the program prompts you to verify your intentions to terminate, then provides you with termination choices. The choices are to terminate without changing the current system configuration or to return the 360 VNA to the standard CW mode.

3-5 SYSTEM START UP

The 360PS20A system operates and performs pulsed and CW measurements under the control of the pulse application software and the 360 VNA system software. The pulse application software is loaded into the computer/controller's memory from its hard disk; the 360 VNA system software is loaded into the network analyzer's memory from the system diskette.

System start up consists of turning on power to the system components and loading the system and application software into memory. The following paragraphs take you through the sequence for 360PS20A system start-up.

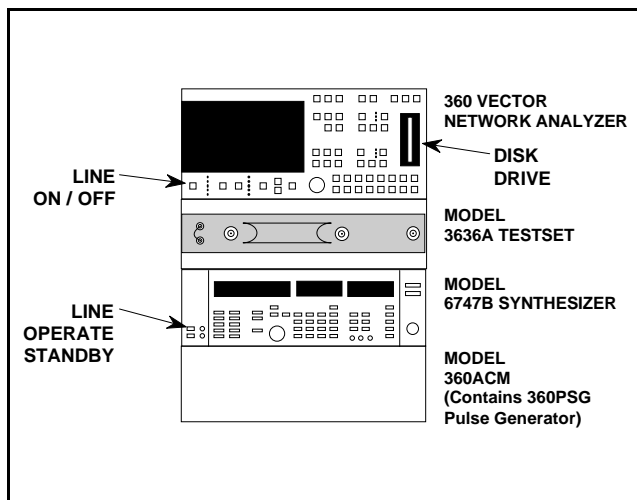

Figure 3-7. 360 VNA System Power Switch Locations

3-5.1 360 VNA Power Up

To power up the 360 VNA, use the following procedure:

1. Install the 360 VNA system diskette (software version 3.07 required) into the disk drive located on the right-hand side of the network analyzer's control panel (Figure 3-7).
2. On the frequency synthesizer, press the LINE OPERATE-STANDBY switch, located on the left-hand side of the front panel, to OPERATE. Note that the OPERATE indicator lights (Figure 3-7).
3. On the network analyzer, press the LINE ON-OFF switch, located on the left-hand side of the front panel, to ON (Figure 3-7). Note that the LEDs on the front panel light. This indicates that a system self-test is in progress.

After several seconds, the screen on the network analyzer displays a message indicating the version of software that is performing the self-test and the message – **RUNNING SELF TEST**.

NOTE

Error conditions detected during system self-test are displayed as error messages on the screen. They should be corrected before continuing. Refer to the Model 360 Vector Network Analyzer Operation Manual for a listing of error messages and probable causes.

Normally, within a few moments, the message – **SELF TEST PASSED** – is displayed and the system program begins loading from the system diskette. During program loading the LED on the disk drive lights and the screen displays the message – **LOADING PROGRAM FROM DISK**.

After approximately one minute, the program is loaded and the VNA system returns to the exact status and display that it was in when last turned off.

3-5.2 Pulse Generator Power Up

The 360PSG system pulse generator is mounted inside the 360ACM auxiliary control module and faces the rear of the 360 VNA console. The system pulse generator receives its primary power from the auxiliary control module. To access the 360PSG and its front panel controls, open the rear door of the console and look directly below the frequency synthesizer.

On the system pulse generator, press the POWER ON-OFF switch, located on the right-hand side of the front panel, to ON (Figure 3-8). Note that model number, firmware version, and serial number information is displayed briefly on the front panel LCD when the power is first applied.

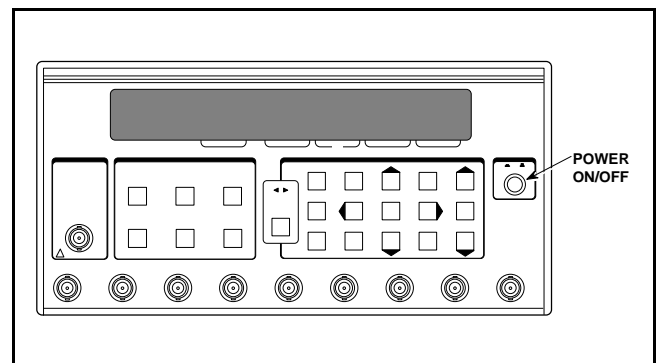

Figure 3-8. Pulse Generator Power Switch Location

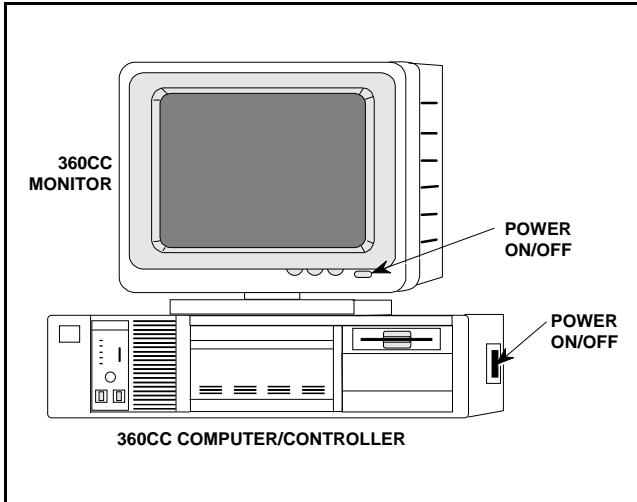

Figure 3-9. 360CC Power Switch Locations

3-5.3 Computer/Controller Power Up

To power up the 360CC computer/controller, proceed as follows:

1. On the computer/controller's monitor, press the POWER ON-OFF switch to the ON position. (Figure 3-9)
2. On the computer/controller, place the red POWER ON-OFF switch, located on the left-hand side panel, to the ON position (Figure 3-9).

The computer first performs a self-test of its memory, then boots. Once the computer/controller is fully booted, the display shown in Figure 3-10 appears on the computer/controller's display screen. You are now ready to load the 360PS20A pulse application software into the computer/controller's memory.

CAUTION

The power cables for the Ink Jet printer and the printer buffer both have power modules and look the same but each one outputs a different voltage. The printer power module converts 115 Vac to 9 Vac; the printer buffer power module converts 115 Vac to 9 Vdc. Equipment damage can result if the wrong power cable is connected. Before continuing, verify proper connection of these power cables.

3-5.4 Print Buffer and Printer Power Up

To power up the print buffer and printer, proceed as follows:

1. On the printer buffer, place the ON-OFF rocker switch, located on the back panel, to the ON position. Note that LEDs on the front panel light.
2. On the printer, place the ON-OFF rocker switch, located on the back panel, to the ON position. Note that the PWR indicator, located on the left-hand side of the printer top, lights.

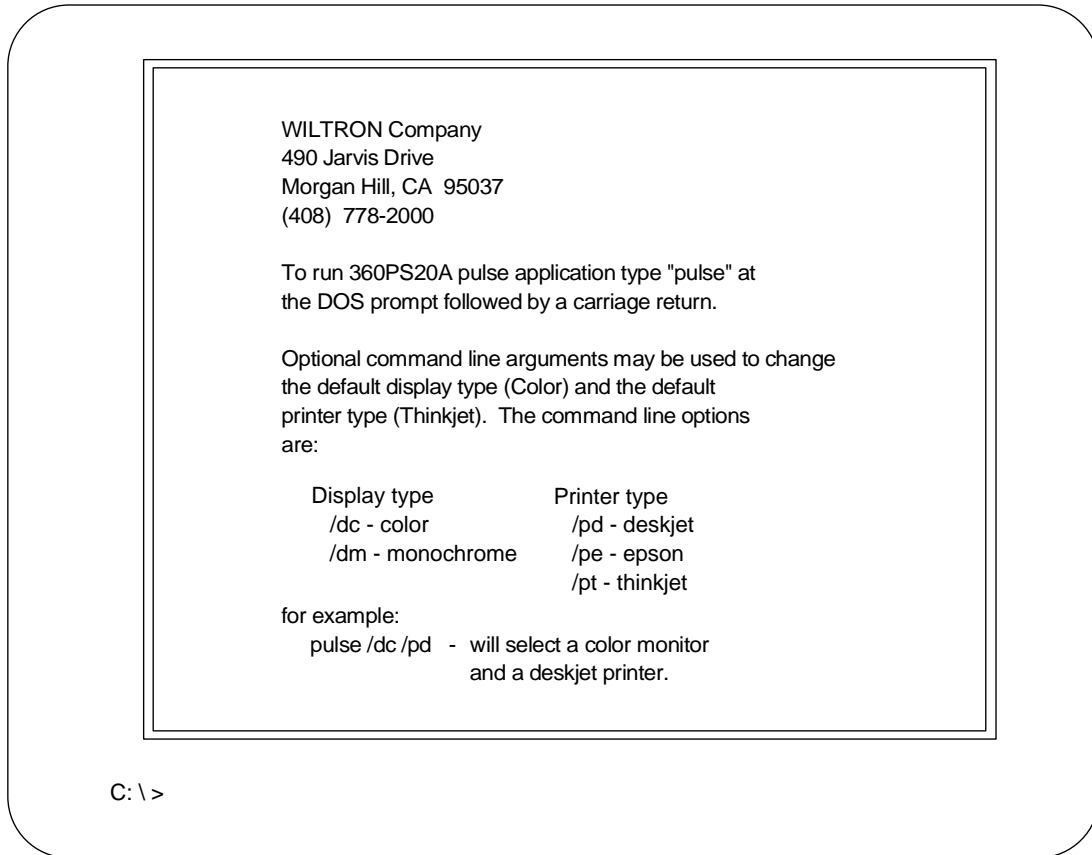

Figure 3-10. Computer/Controller's Start Up Display Screen

3-5.5 Loading the Program

The 360PS20A pulse application software program is designed to operate with two display types – color VGA and monochrome VGA. The program supports three printer types – the HP Deskjet printer type, the Epson (EX, FX, LX, and compatible) printer type, and the HP Thinkjet printer type. When loading the pulse application software program, optional command line arguments are used to change the default display type (color VGA) and default printer type (HP Thinkjet). The optional command line arguments are:

/dc – color VGA display
/dm – monochrome VGA display
/pd – HP Deskjet printer
/pe – Epson printer
/pt – HP Thinkjet printer

To load and run the 360PS20A pulse application software program, proceed as follows:

1. To accept the default display and printer types, at the DOS prompt (C:\>),
type: pulse
then press <ENTER>.
2. To change the default display and/or default printer types, at the DOS prompt (C:\>),
type: pulse (followed by the appropriate command line arguments)
then press <ENTER>.

When the pulse application software program is loaded and ready to run, the program title screen (Figure 3-11, page 3-18) is displayed.

3-6 MAKING PULSED MEASUREMENTS

The pulse application software program provides menus that make it easy for you to setup the system and perform pulse measurements. After a pulsed measurement has been performed, the program displays the measurement data graphically on a data display. It also provides you with data display control and enhancement features to enable you to analyze the results and generate hardcopy printouts of the measurement data in both graphical and tabular formats. In addition to menus, dedicated function keys are provided to allow easy access to the menus and menu items that are selected repetitively during operation.

The written descriptions and procedures, figures, and tables on the following pages will provide you with details about each of the program features, menus, and data displays to enable you to setup and perform pulse measurements. Parameter limits, constraints, and default settings are also provided.

NOTE

Procedures for 360 VNA setup, calibration, measurement, and data display are not covered in this operator manual. Refer to the Model 360 VNA Operation Manual for this information.

3-6.1 Menus and Data Displays

Pulse application program menus provide you with fast, easy control of the pulse measurement process. The data displays give a graphic presentation of the pulse profile measurement results.

a. Use of Colors

The use of colors in the pulse application program menus and data displays enables you to readily identify display elements. Each color used is dedicated to a specific function and is patterned after the 360 VNA color implementation. The colors used and their assigned functions are as follows:

- **Blue:** Used for instructional messages and heading identifiers on all displays. It is also used for the active marker on data displays.

- **Green:** Used for items that can be selected or changed by the operator such as pulse parameters and menu selection identifiers. It is used for lines, display graticules, and all text associated with the graticules. Green is also the color used to plot a trace memory data trace on a data display and for the graphic simulation of the current stimulus and profile pulse parameters displayed as part of the Setup Menu, Calibrate Menu, and during pulse profile measurement.
- **Red:** Used for error and warning messages, to identify invalid pulse parameters, and to plot a measurement data trace. A red cursor (>) is used as a menu pointer to indicate a menu selection and as the reference line pointer on data displays.
- **Yellow:** Used for two markers on the graphic portion of the Setup Menu display to indicate the start and stop points of the pulse profile measurement. Yellow is also the color used for two inactive markers on data displays that indicate where the leading and trailing edges of the stimulus pulse theoretically appear.

NOTE

Even if your system is equipped with a monochrome VGA display, you will be able to distinguish the difference between display elements. They appear as different shades of the monochrome color.

b. Selecting Menu Items and Entering Data

The pulse application program uses different types of menu items. When selected, some menu items cause another menu to be displayed, some allow selection of options or turn an operation or function on and off, and some require data to be entered.

All menu items are selected the same way. You select a menu item by positioning the menu pointer (>) adjacent to the desired menu item. Move the menu pointer up and down using with the ↑ and ↓ keys on the keyboard.

For those menu items that allow selection of options or turn an operation or function on or off, press <ENTER> to toggle the available options or settings. For those menu items that require data entry, input the data on the keyboard, then press <ENTER>.

3-6.2 Function Keys

The function keys located on the keyboard of the 360CC Computer/Controller are assigned to dedicated functions by the pulse application program. They reduce the number of keystrokes necessary to setup and perform pulse measurements and to display and output pulse profile measurement results.

A function key menu strip is provided with the 360PS20A system. When placed on the computer/controller's keyboard, it provides rapid identification of the dedicated function keys.

Table 3-1, shown below, lists each of the assigned function keys with a definition of its function.

Table 3-1. Function Key Assignments

Function Key	Definition
F2	Displays the Main Menu — this menu provides selection of the main pulse application program operations.
<Shift> F2	Displays the Configuration Menu — this menu provides the capability to individually control the stimulus pulse modulator and the profile pulse modulators and to specify whether the pulse generator trigger source is internal or external.
F3	Displays the Setup Menu — this menu provides the capability to control all pulse parameters for either a fixed or pulse profile measurement and to set the CW frequency and averaging for a pulse profile measurement.
<Shift> F3	System Default — reconfigures the 360PS20A system to start up condition.
F4	Displays the Calibrate Menu — this menu prompts the operator to perform a calibration on the 360 VNA system.
F5 ^①	Measure — initiates a pulse profile measurement.
F6 ^②	Invokes the Display Menu — this menu enables selection of the data display enhancement functions of scaling, trace memory, S-parameter selection, graph type selection, marker set, and data output.
F7 ^③	Scale Menu — this menu permits entry of scale reference, resolution, and reference line position for the data display.
F8 ^③	Autoscales the pulse profile measurement data display for reference and resolution.
F9 ^③	Displays the Marker Menu — this menu provides the capability to control an active marker.
F10 ^③	Displays the Output Menu — this menu provides the capability to specify the type of pulse profile measurement data printout.
<Shift> F10 ^③	Print Data — initiates the printout of the pulse profile measurement data in the format specified by the Output Menu selection.
<Alt> F10	Print Parameters — initiates the printout of the pulse system parameters.
<Ctrl> Break	Abort Print — terminates the printout of the pulse system parameters or the pulse profile measurement data.
Esc	Escape — displays the previous menu.

^① F5 is only active when the pulse profile measurement mode is selected on the Setup Menu.

^② F6 is only active when a valid pulse profile measurement has been made. If any pulse parameter is changed after the pulse profile measurement was taken, F6 will be inactive until a new measurement is taken.

^③ F7, F8, F9, F10, and <Shift> F10 are only active when pulse profile measurement data is displayed on the computer/controller's display.

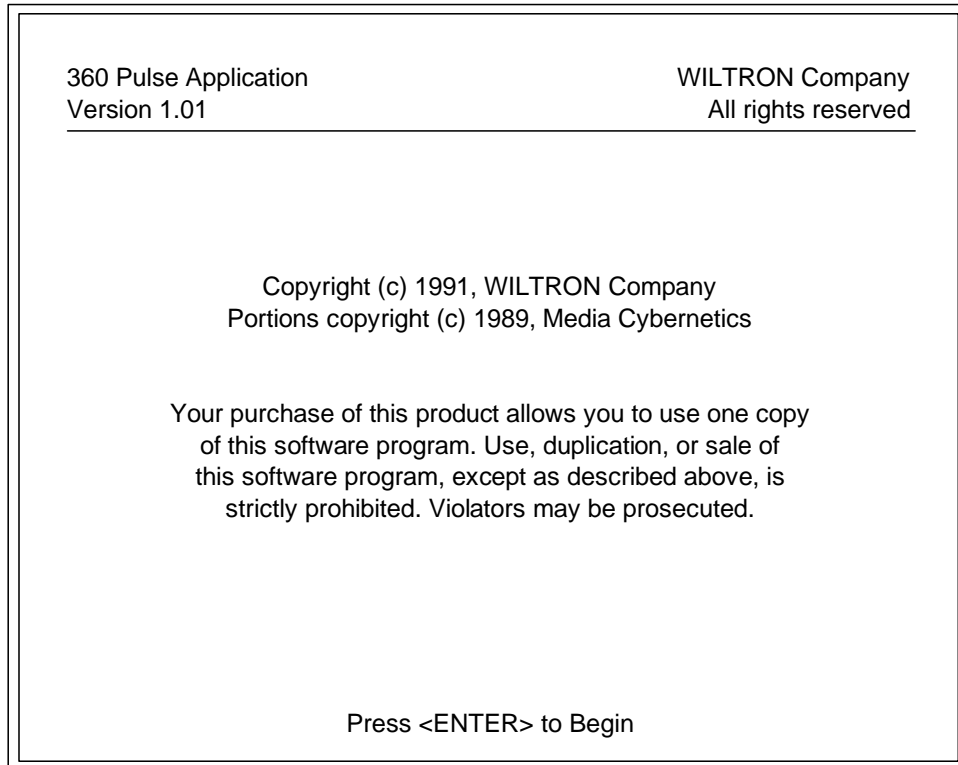

Figure 3-11. Pulse Application Program Title Screen

CAUTION

When the pulse application program is running, pressing <Ctrl> C or <Ctrl> Break will cause the program to abort. To restart the program, at the DOS prompt type: pulse, then reload the program following the procedures in paragraph 3-5.5.

3-6.3 Program Title Screen

When the pulse application software program is loaded and ready to run, the title screen (Figure 3-11) is displayed. The title screen provides you with the software version number and copyright information.

When you are ready to start the pulsed measurement process, press <ENTER>.

NOTE

If you need to make any changes to the 360 VNA setup, such as source power or test set attenuator settings, they should be performed at this time as the 360 VNA is in local mode. Once you start the pulsed measurement process from the Main Menu (Figure 3-12), the 360 VNA is placed in remote mode. During pulsed measurements, you can place the 360 VNA in local mode by selecting **CALIBRATE** from the Main Menu or by setting the Setup Menu item **MEAS MODE:** to **fixed profile**.

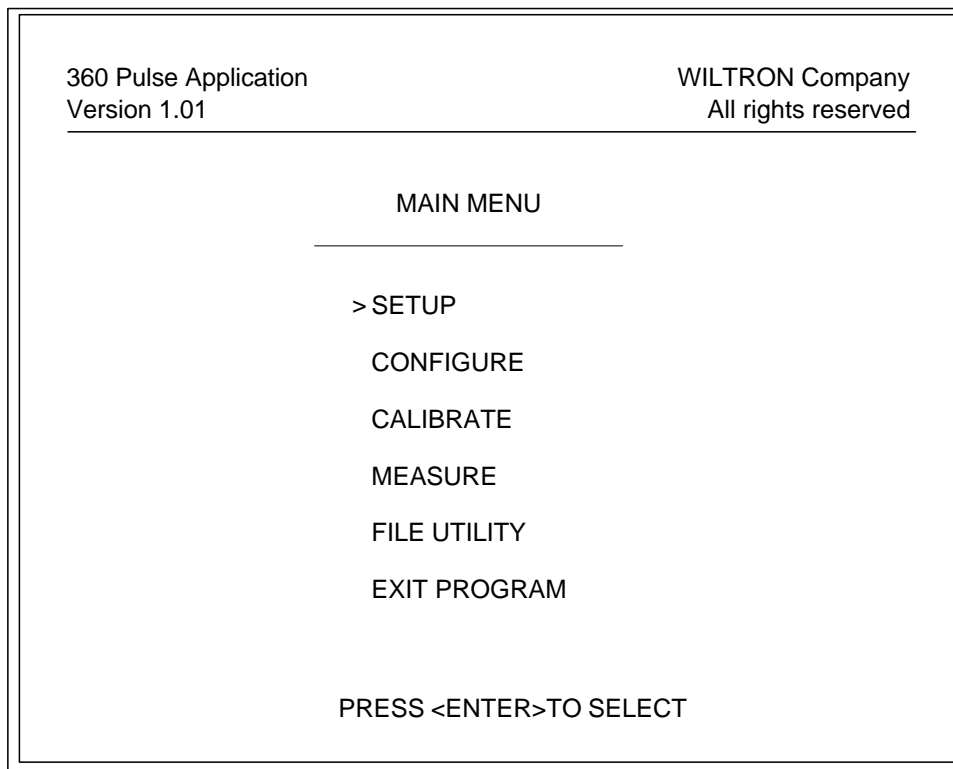

Figure 3-12. Main Menu Display

3-6.4 Main Menu Selections

When you begin the pulse measurement process, the first menu is the Main Menu (Figure 3-12). This menu gives you access to each of the main operations involved in pulse measurement, as well as the file utility component of the program.

a. Selecting a Menu Item

Select a menu item by positioning the menu pointer (>) adjacent to the item, then pressing <ENTER>. Move the menu pointer up and down with the ↑ and ↓ keys. This menu driven interface is similar to the one used on the 360 network analyzer.

You also have the option to select certain menu items using the dedicated function keys;

- F3 to select **SETUP**.
- <Shift> F2 to select **CONFIGURE**.
- F4 to select **CALIBRATE**.
- F5 to select **MEASURE**.

NOTE

Selecting any Main Menu item, except for **CALIBRATE**, **FILE UTILITY**, or **EXIT PROGRAM**, automatically places the 360 network analyzer and the pulse generator in remote mode (under GPIB control).

b. Menu Item Descriptions

SETUP — Selecting **SETUP** causes the program to display the Setup Menu. This menu lets you specify the type of measurement to be performed and to control all pulse parameters for either a pulse profile measurement or a fixed profile pulse measurement. In addition, it lets you set the CW frequency and averaging for a pulse profile measurement. Refer to figures 3-13 through 3-16 for Setup Menu displays and paragraph 3-6.5 for the Setup Menu data entry and option selection procedures.

CONFIGURE — When you select **CONFIGURE**, the program displays the Configuration Menu. This menu lets you individually control the mode of operation of the stimulus pulse modulator and the profile pulse modulators located in the 3636A Pulsed/CW Test Set. It also lets you specify whether the pulse generator trigger source is internal or external. See Figure 3-18 for the Configuration Menu

display and paragraph 3-6.6 for menu option selection details.

CALIBRATE — When **CALIBRATE** is selected, the Calibrate Menu is displayed and you are directed to perform a calibration on the 360 VNA. Figure 3-19 shows the Calibrate Menu display and paragraph 3-6.7 provides information concerning the calibration options available.

MEASURE — Selecting **MEASURE** causes the program to initiate a pulse profile measurement, if the Setup Menu item **MEAS MODE:** is set to **pulse profile**. If the Setup Menu item **MEAS MODE:** is set to **fixed profile**, selecting **MEASURE** causes the program to display the Setup Menu. Refer to paragraph 3-6.8 for pulse measurement information. Figure 3-20 shows the display during a pulse profile measurement.

FILE UTILITY — Selecting **FILE UTILITY** calls the File Utility Menu. This menu gives you access to the File Utility module of the pulse application program. This module lets you do the following:

- Save system calibrations, setup configurations, and measurement data as files on either the computer/controller's hard disk or a floppy disk.
- Recall the stored files whenever required.
- Perform the basic file operations of delete, copy, rename, and list file directory.

Refer to paragraph 3-7 for detailed information and instructions for using the File Utility Menu.

EXIT PROGRAM — When you select **EXIT PROGRAM**, the message – **Are you sure you want to exit (Y/N)?** – appears at the bottom of the display. Type **Y** (for Yes) or **N** (for No), then press <ENTER>.

1. If you respond **N**, the program redisplay the Main Menu.

2. If you respond **Y**, the message – **Return the 360 to the standard cw mode (Y/N)?** – will then appear at the bottom of the display. Once again, type **Y** (for Yes) or **N** (for No), then press <ENTER>.

- (a) If you respond **N**, the program terminates without changing the system configuration.
- (b) If you respond **Y**, the program does the following:
 - (1) Places the 360 VNA in the STANDARD receiver mode.
 - (2) Resets the 360 VNA.
 - (3) Causes the pulse generator to output a dc voltage that places the test set pulse modulators in CW mode (non-pulsing, on state).
 - (4) Terminates.

c. Warning Messages

If you have not performed a calibration on the system since startup, the warning message – **SYSTEM UNCALIBRATED** – is displayed in red along the bottom of the Main Menu display. The warning message remains until you perform a calibration from the Calibrate Menu, or until you recall a calibration from the File Utility Menu.

Once a calibration has been performed, if you change a pulse parameter that affects the duty cycle of either the stimulus or profile pulse, the warning message – **CAL MAY BE INVALID** – is displayed in red along the bottom of the Main Menu display. The pulse parameters that affect duty cycle are PRF, stimulus pulse width, and profile pulse width as well as the stimulus and profile mode settings.

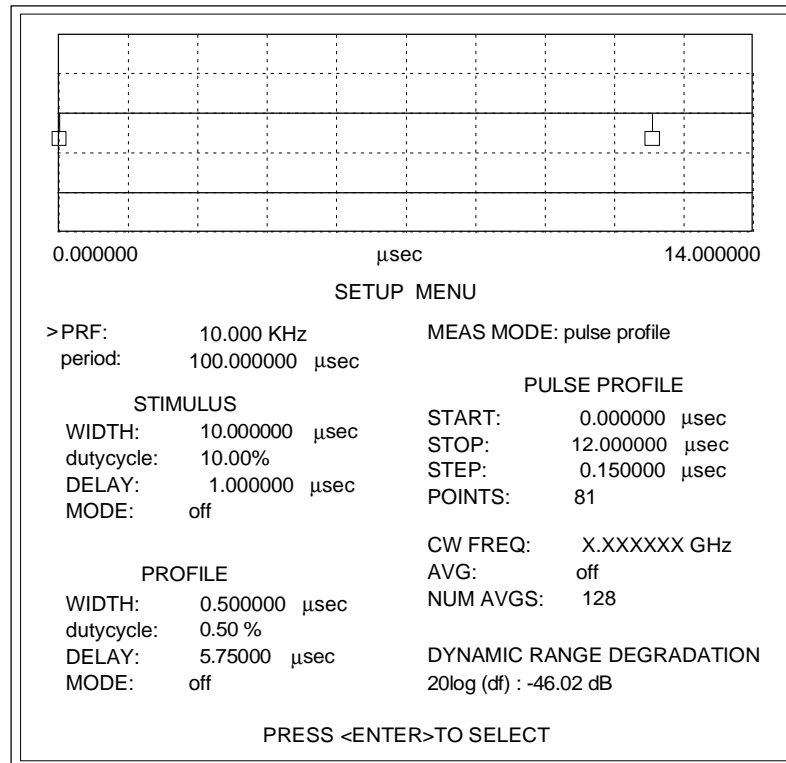

Figure 3-13. Setup Menu Display (Showing Default Pulse Parameters)

3-6.5 Setting Pulse Parameters

The Setup Menu (Figure 3-13) lets you specify the type of measurement to be performed and control all pulse parameters for either a pulse profile measurement or a fixed profile pulse measurement. Additionally, it lets you set the CW frequency and averaging for a pulse profile measurement. There are two ways to display the Setup Menu. They are:

- From the Main Menu, select **SETUP**, then press <ENTER>.
- From any menu of the pulse application program, press function key, F3.

The upper one-third of the Setup Menu display is a graphic simulation of the pulse generator stimulus and profile pulse outputs that are currently being applied to the test set stimulus and profile modulators. When the menu items **(STIMULUS) MODE** and **(PROFILE) MODE** are both set to **pulse**, the simulation shows the relative width and position of the profile pulse in relation to the stimulus pulse (Figures 3-14 and 3-15). In addition, when the menu item **MEAS MODE**: is set to **pulse profile**, markers indicating the start and stop points of the pulse profile measurement are also shown.

a. Default Pulse Parameters

When you initially start the pulse application program or whenever you initiate a system default (<Shift> F3), the Setup Menu is configured to the default pulse parameters shown in Figure 3-13. The menu items **(STIMULUS) MODE**: and **(PROFILE) MODE**: are both set to **off**. The graphic simulation shows that the pulse generator stimulus and profile pulse outputs currently being applied to the modulators of the test set are dc voltages. These voltages place the stimulus pulse modulator and the profile pulse modulators in a non-pulsing, off state to prevent damage to the DUT. The menu item **CW FREQ**: shows an entry of **X.XXXXXX GHz**. The **X.XXXXXX** indicates that the CW frequency is determined by the 360 VNA.

b. Menu Selection and Data Entry

You select a menu item by positioning the menu pointer (>) adjacent to the item. Move the menu pointer with the ↑ and ↓ keys. Once you have selected a menu item, enter data or change current settings as follows:

- For items requiring numeric data entries, type in the data on the keyboard, then press <ENTER>.

- For other items, press <ENTER> to toggle the available setting selections.

The following menu items are not selectable; **period**., **(STIMULUS) dutycycle**., **(PROFILE) dutycycle**., and **DYNAMIC RANGE DEGRADATION**. Their values are calculated by the program based upon the pulse parameters you input. The **DYNAMIC RANGE DEGRADATION** value of $20\log (df)$ is always calculated using the smallest duty cycle (stimulus pulse or profile pulse).

c. Pulse Parameter Limits and Constraints

When entering setup data in preparation for a pulse measurement, there are certain *limits* and *constraints* placed on pulse parameter entries. In general, pulse parameter *limits* are the result of system hardware limitations. The pulse parameter *limits* are shown in Table 3-2.

Table 3-2. Pulse Parameters Limits

Pulse Parameter	Lower Limit	Upper Limit
Pulse Repetition Frequency (PRF)	1.000 kHz	980.000 kHz
Pulse Width	0.0200000 μ sec	999.000000 μ sec
Duty Cycle	0.10 % (minimum)	
Pulse Delay	0.000000 μ sec	998.000000 μ sec
Pulse Profile Start	0.000000 μ sec	997.999995 μ sec
Pulse Profile Stop	0.000005 μ sec	998.000000 μ sec
Pulse Profile Step	0.000005 μ sec	998.000000 μ sec
Pulse Profile Points	2 points	501 points
CW Frequency	0.890000 GHz	20.000000 GHz
Number of Averages	2 averages	4095 averages

Pulse parameter *constraints* are imposed to prevent conflicts between pulse parameters. The pulse parameter *constraints* are as follows:

- **Stimulus Pulse Constraint** (Width and Delay):
 $0.02 \mu s \leq PW (\mu s) + DELAY (\mu s) < period (\mu s) - 1 \mu s$
- **Profile Pulse Constraint** (Width and Delay):
 $0.02 \mu s \leq PW (\mu s) + DELAY (\mu s) < period (\mu s) - 1 \mu s$
- **Pulse Profile Constraint** (Width, Start, and Stop):
 Profile $PW (\mu s) + Stop (\mu s) < period (\mu s) - 1 \mu s$
 given: $0 \leq Start (\mu s) < Stop (\mu s)$

d. Setting Stimulus and Profile Modes

The menu items, **(STIMULUS) MODE**.; and **(PROFILE) MODE**.; are used to control the operation of the stimulus pulse modulator and the profile pulse modulators in their current modes of operation. The stimulus pulse modulator has two modes of operation – *pulse* and *CW*. The profile pulse modulators have three modes of operation – *pulse*, *CW*, and *user*. The default mode of operation for both the stimulus pulse modulator and the profile pulse modulators is *pulse*. This is the mode of operation that is set when you start up the program and whenever you initiate a system default (<Shift> F3). The Configuration Menu is used to individually control the mode of operation of the stimulus and profile pulse modulators (paragraph 3-6.6).

When the stimulus pulse modulator is set to operate in the *pulse* mode of operation, selecting the Setup Menu item, **(STIMULUS) MODE**.; and pressing <ENTER> toggles the mode entry between **pulse** and **off**. When the mode entry is **pulse**, the pulse generator outputs stimulus pulses to the stimulus pulse modulator. When the mode entry is **off**, the pulse generator outputs a dc voltage that places the modulator in a non-pulsing, off state.

When the stimulus pulse modulator is set to operate in the *CW* mode of operation, selecting the Setup Menu item, **(STIMULUS) MODE**.; and pressing <ENTER> toggles the mode entry between **cw** and **off**. When the mode entry is **cw**, the pulse generator outputs a dc voltage that places the modulator in a non-pulsing, on state. When the mode entry is **off**, the pulse generator outputs a dc voltage that places the modulator in a non-pulsing, off state.

The Setup Menu item, **(PROFILE) MODE**.; controls the operation of the four profile pulse modulators in all modes of operation in exactly the same manner as the menu item, **(STIMULUS) MODE**.; controls the stimulus pulse modulator. Since the *pulse* and *CW* modes of operation have been thoroughly described already, only the control of the additional *user* mode of operation will be described here.

When the profile pulse modulators are set to operate in the *user* mode of operation, i.e., some modulators set for *CW* mode and the remainder set for *pulse* mode, selecting the Setup Menu item, **(PROFILE) MODE**.; and pressing <ENTER> toggles the mode entry between **user** and **off**. When the mode entry is **user**, the pulse generator outputs profile

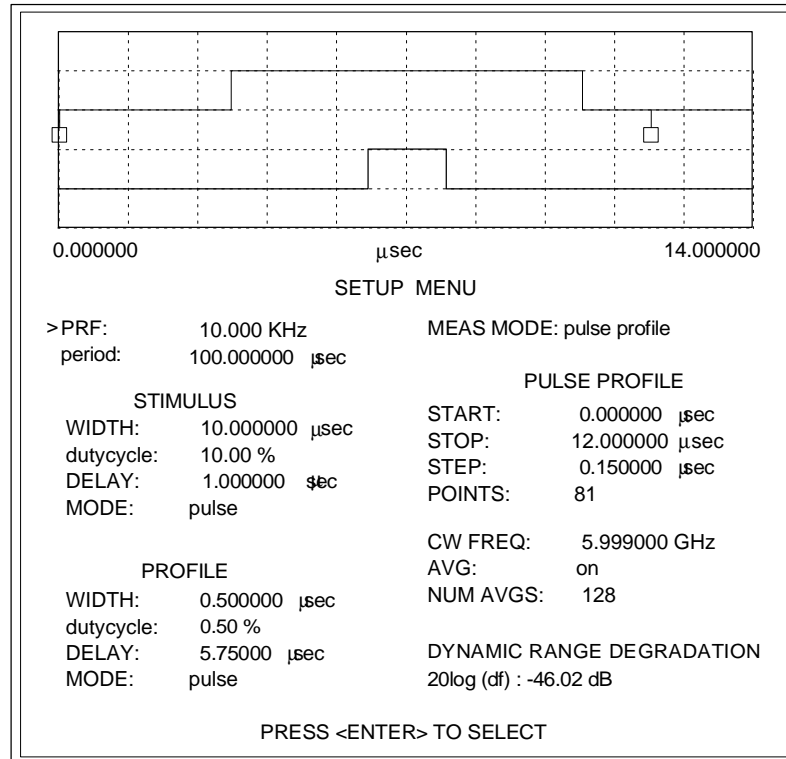

Figure 3-14. Setup Menu Display (Pulse Profile Measurement)

pulses to the modulators. Those modulators that were set for *CW* mode in the Configuration Menu are placed in a non-pulsing, on state and the rest in the *pulse* mode. When the mode entry is *off*, the pulse generator outputs a dc voltage that places all the profile pulse modulators in a non-pulsing, off state.

e. Pulse Profile Measurement Setup

To perform a pulse profile measurement, you first need to enter pulse parameter data and change settings in the Setup Menu (Figure 3-14) as follows:

1. Enter data for the items, **PRF:**, (**STIMULUS**) **WIDTH:** and **DELAY:**, and (**PROFILE**) **WIDTH:**, and **DELAY:**.
2. Set (**STIMULUS**) **MODE:** to **pulse**.
3. Set (**PROFILE**) **MODE:** to **pulse**. (Set to **user** if you have set the profile pulse modulators to a special configuration.)
4. Set **MEAS MODE:** to **pulse profile**. (The **PULSE PROFILE** data fields are displayed on the Setup Menu and the 360 VNA is forced into the CW mode.)
5. Enter data for the items, (**PULSE PROFILE**) **START:** and **STOP:**.

6. Enter data for either of the menu items, (**PULSE PROFILE**) **STEP:** or **POINTS:**. (Enter **STEP:** data and the program calculates **POINTS:** data; enter **POINTS:** data and the program calculates **STEP:** data.)
7. Enter data for the item, **CW FREQ:**. (This sets the 360 VNA CW frequency for the pulse profile measurement. The 360 VNA will accept any valid CW frequency for the current calibration. If no calibration exists, the full frequency range of the signal source is available.)

NOTE

If the item **CW FREQ:** is blue, the 360 VNA is in single point measurement mode and no other CW frequency entries are allowed.)

8. If you desire averaging in the 360 VNA during the pulse profile measurement, set **AVG:** to **on** and enter data for the item, **NUM AVGS:**.

You are now setup to perform a pulse profile measurement. If you wish to perform a calibration of 360 VNA prior to making the measurement, press func-

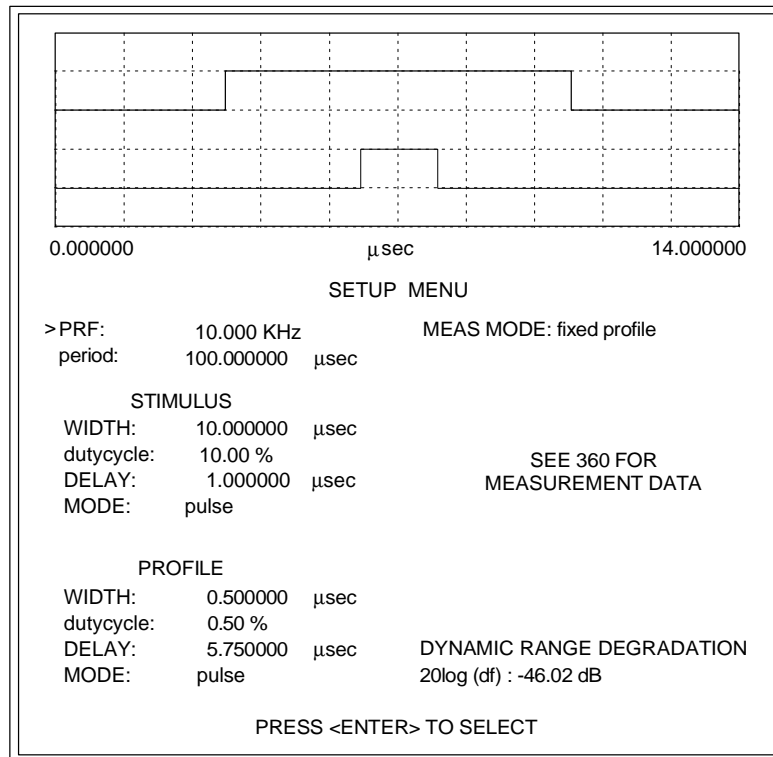

Figure 3-15. Setup Menu Display (Fixed Profile Pulse Measurement)

tion key F4 to access the Calibrate Menu. If you wish to initiate the pulse profile measurement, press function key F5.

f. Fixed Profile Pulse Measurement Setup

To perform a fixed profile pulse measurement, you first need to enter pulse parameter data and change settings in the Setup Menu (Figure 3-15) as follows:

1. Set **MEAS MODE:** to **fixed profile**. (Setting this menu item first avoids pulse profile parameter conflicts.)
2. Enter data for the items, **PRF:**, (**STIMULUS**) **WIDTH:** and **DELAY:**, and (**PROFILE**) **WIDTH:** and **DELAY:**.
3. Set (**STIMULUS**) **MODE:** to **pulse**.
4. Set (**PROFILE**) **MODE:** to **pulse**. (Set to **user** if you have set the profile pulse modulators to a special configuration.)

The message – **SEE 360 FOR MEASUREMENT DATA** – now appears near the middle of the right-hand side of the Setup Menu. The 360 VNA is placed in local mode for a fixed profile pulse measurement. You then perform the necessary calibration, set the measurement parameters (start frequency, stop frequency, data points, averaging,

etc.), and perform the measurements from the 360 VNA front panel. The data resulting from the fixed profile pulse measurement is displayed only on the 360 VNA display. All 360 VNA display and analysis features can be applied to the results. Refer to the Model 360 VNA Operation Manual for detailed operating procedures.

During fixed profile pulse measurement, the Setup Menu shown in Figure 3-15 remains displayed on the computer/controller’s monitor. You can exit the Setup Menu in one of two ways; (1) press the ESC key to return to the previous menu, or (2) press the function key F2 to display the Main Menu.

To terminate a fixed profile measurement or to exit the fixed profile measurement mode and return the 360 VNA to remote control, set the menu item, **MEAS MODE:**, to **pulse profile**.

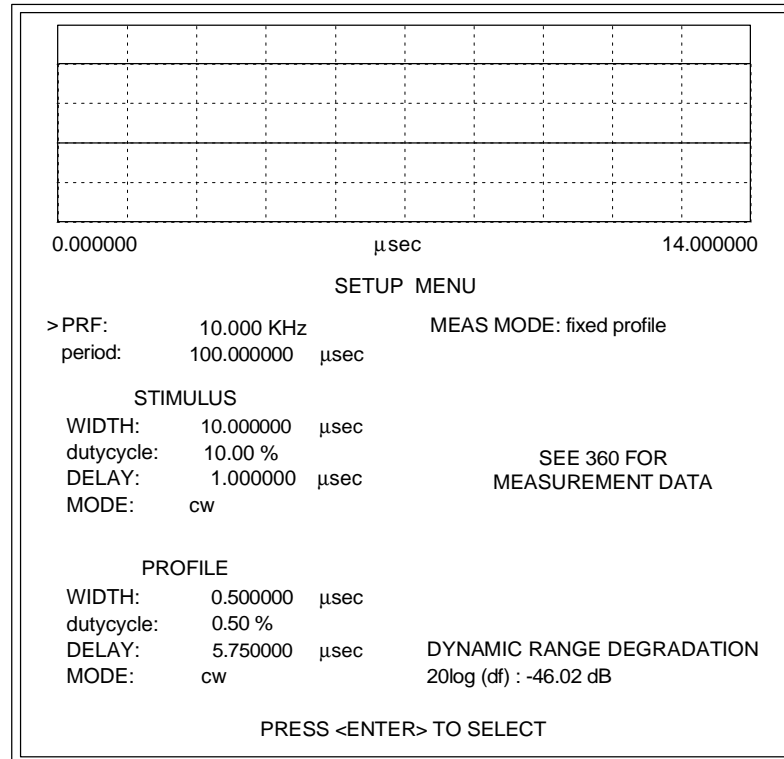

Figure 3-16. Setup Menu Display (CW Measurement)

NOTE

Before you can configure the Setup Menu for a CW measurement, the stimulus and profile pulse modulators must be set to the *CW* mode of operation using the Configuration Menu.

g. CW Measurement Setup

To perform a CW measurement, you need to change settings in the Setup Menu (Figure 3-16) as follows:

1. Set **(STIMULUS) MODE:** to **cw**.
2. Set **(PROFILE) MODE:** to **cw**.
3. Set **MEAS MODE:** to **fixed profile**.

The graphic simulation shows that the pulse generator stimulus and profile pulse outputs currently being applied to the modulators in the test set are dc voltages. These voltages place the stimulus pulse modulator and the profile pulse modulators in a non-pulsing full on state.

The message – **SEE 360 FOR MEASUREMENT DATA** – appears near the middle of the right-hand side of the Setup Menu and the 360 VNA is placed in local mode. During CW measurements, you perform the necessary calibration, set measurement parameters, perform measurements, and display

the measurement results all on the 360 VNA. Refer to the Model 360 VNA Operation Manual for detailed operating procedures.

During CW measurements, the Setup Menu shown in Figure 3-16 remains displayed on the computer/controller's monitor. You can exit the Setup Menu display in one of two ways; (1) press the ESC key to return to the previous menu, or (2) press the function key F2 to display the Main Menu.

To terminate CW measurements and return the 360 VNA to remote control, set the menu item, **MEAS MODE:**, to **pulse profile**.

h. Error and Warning Messages

Pulse parameters are checked by the program for validity at the moment you enter them. If you enter an invalid pulse parameter (outside the specified limits), the parameter is displayed in red and an error message – **INVALID PARAMETER** – is displayed in red along the bottom of the Setup Menu display. The menu pointer remains fixed at the invalid item and continues to remain inactive as long as the parameter is invalid. To reactivate the menu pointer, you can enter a valid parameter or press <ESC> to restore the previous value of the out-of-range parameter.

When you enter a pulse parameter that results in conflicting pulse parameters, the conflicting pulse parameters are displayed in red and the error message – **CONFLICTING PARAMETERS** – is displayed in red along the bottom of the Setup Menu display. The menu pointer remains active while the error message is displayed, allowing you to modify any pulse parameter. You can *not* exit the Setup Menu while the error message is displayed. An example of conflicting parameters is a stimulus pulse width that exceeds the period. In this case, both the PRF and stimulus pulse width parameters would be displayed in red.

If you have not performed a calibration on the system since startup, the warning message – **SYSTEM UNCALIBRATED** – is displayed in red along the bottom of the Setup Menu display. The warning message remains displayed until you perform a calibration from the Calibrate Menu, or until you recall a calibration from the File Utility Menu.

Once a calibration has been performed, if you change a pulse parameter that affects the duty cycle of either the stimulus or profile pulse, the warning message – **CAL MAY BE INVALID** – is displayed in red along the bottom of the Setup Menu display. (This warning message is also displayed along the bottom of the Calibrate Menu display, the Main Menu display, the Configuration Menu display, and the display generated during pulse profile measurement. The warning message is *not* displayed on any of the data display menus.) The pulse parameters that affect duty cycle are PRF, stimulus pulse width, and profile pulse width as well as the stimulus and profile mode settings.

i. Saving/Recalling Setup Data

You can save a system setup configuration (pulse parameters and 360 VNA instrument state) to a file on the computer/controller's hard disk or on a floppy disk. You can recall a previously saved setup configuration file from the computer/controller's hard disk or from a floppy disk. To save or recall a setup configuration:

1. Press function key F2 to display the Main Menu.
2. Select menu item **FILE UTILITY**, then press <ENTER>.
3. Proceed to paragraph 3-7 for procedures to save or recall a setup configuration file.

```

HILTRON

360PS20A VNA PULSE SYSTEM PARAMETERS                                     Page 1

PRF:      10.000 KHz          STIMULUS PULSE          MEAS MODE: pulse profile
period: 100.000000 usec      WIDTH:      10.000000 usec
                                duty cycle: 10.00 %
                                DELAY:      1.000000 usec
DYNAMIC RANGE DEGRADATION    MODE:      pulse
20log(df): -46.02 dB

                                PROFILE PULSE
                                WIDTH:      0.500000 usec
                                duty cycle: 0.50 %
                                DELAY:      5.750000 usec
                                MODE:      pulse
                                PULSE PROFILE
                                START:      0.000000 usec
                                STOP:      12.000000 usec
                                STEP:      0.150000 usec
                                POINTS:      81
                                CWFREQ: 20.000000 GHz
                                AVG:      off
                                NUM AVGS: 128

```

Figure 3-17. Example of a Pulse Parameter Printout

j. Printing the Pulse Parameters

You can print out a tabular listing of the pulse parameters by pressing <Alt> F10. Figure 3-17 provides an example of a pulse parameter printout.

Once the printer has started printing out the pulse parameters, you can abort the printout by pressing <Ctrl> Break.

k. Exiting the Menu

When you are ready to exit the Setup Menu, the exit options available to you depend upon the measurement mode you have set. If you have set **MEAS MODE**: to **pulse profile**, you may exit using one of the following options:

- Press <ESC> to display the previous menu.
- Press function key F2 to display the Main Menu.
- Press function key <Shift> F2 to display the Configuration Menu.
- Press function key F4 to display the Calibrate Menu.
- Press function key F5 to initiate a pulse profile measurement.

If you have set **MEAS MODE**: to **fixed profile**, you may only exit using the following options:

- Press <ESC> to display the previous menu.
- Press function key F2 to display the Main Menu.

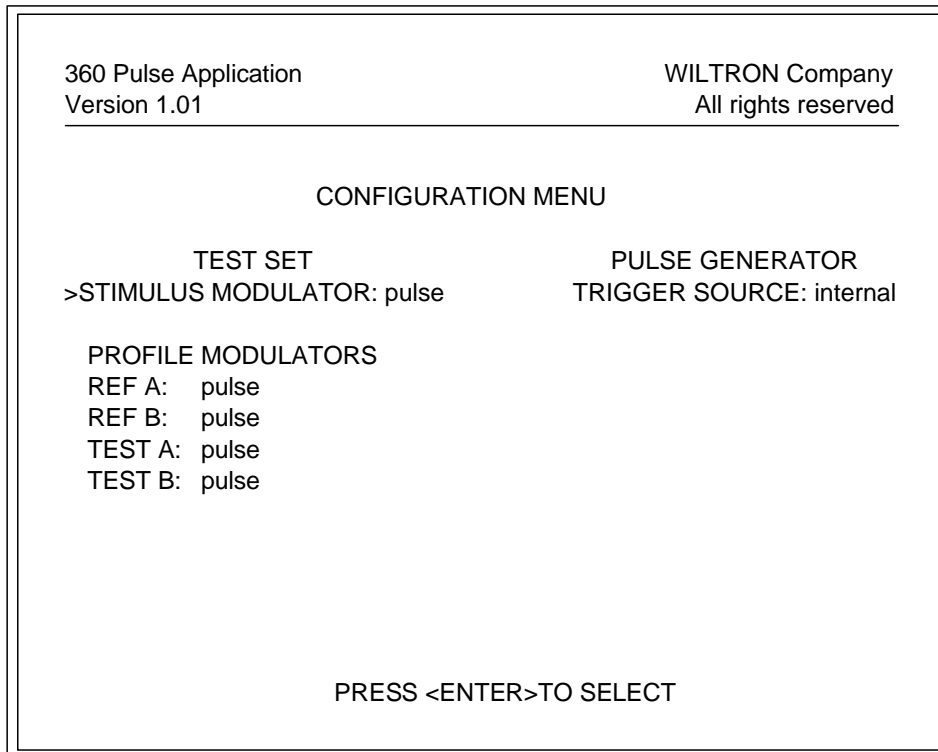

Figure 3-18. Configuration Menu Display

3-6.6 Configuring the Pulse Modulators

The Configuration Menu (Figure 3-18) gives you the capability to individually control the mode of operation of the stimulus pulse modulator and the profile pulse modulators that are located in the 3636A Pulsed/CW Test Set. It also lets you specify whether the system pulse generator trigger source is internal or external. There are two ways to display the Configuration Menu. They are:

- From the Main Menu, select **CONFIGURE**, then press <ENTER>.
- From any menu of the pulse application program, press function key <Shift> F2.

You select a menu item by positioning the menu pointer (>) adjacent to the item. Move the menu pointer with the ↑ and ↓ keys. Once you have selected a menu item, pressing <ENTER>, toggles the available settings.

NOTE

Changing the operational mode of a test set stimulus or profile pulse modulator in the Configuration Menu automatically changes the available selections for the Setup Menu item, **(STIMULUS) MODE:** or **(PROFILE) MODE:**.

a. Setting Test Set Modulator Modes

Stimulus Pulse Modulator – The Configuration Menu item **STIMULUS MODULATOR:** lets you set the test set stimulus pulse modulator to operate in either the *pulse* or *CW* mode. The default setting is *pulse* mode. To change the current stimulus pulse modulator setting, proceed as follows:

1. Position the menu pointer (>) at **STIMULUS MODULATOR:**
2. Press <ENTER> to select either **pulse** or **cw**.

When the stimulus pulse modulator is set to *pulse* mode in the Configuration Menu, the Setup Menu item **(STIMULUS) MODE:** permits selection of either **pulse** or **off**. When the stimulus pulse modulator is set to *CW* mode in the Configuration Menu, the Setup Menu item **(STIMULUS) MODE:** permits selection of either **cw** or **off**.

Profile Pulse Modulators – The Configuration Menu items **REF A:**, **REF B:**, **TEST A:**, and **TEST B:** lets you individually control the operational mode of the profile pulse modulators in the test set channels R_A , R_B , T_A , and T_B (Figure 3-2, page 3-6). You can set each modulator to operate in either the *pulse* mode or *CW* mode. The default setting for each profile pulse modulator is *pulse* mode. To change an individual profile pulse modulator mode setting, proceed as follows:

1. Position the menu pointer (>) at the profile pulse modulator to be changed (**REF A:**, **REF B:**, **TEST A:**, **TEST B:**).
2. Press <ENTER> to select either **pulse** or **cw**.
3. Repeat steps 1 and 2 until you have set all modulators to the desired operational mode.

When all four profile pulse modulators are set to *pulse* mode in the Configuration Menu, the Setup Menu item **(PROFILE) MODE:** permits selection of either **pulse** or **off**. When any single profile pulse modulator is changed from *pulse* mode to *CW* mode in the Configuration Menu, the Setup Menu item **(PROFILE) MODE:** permits selection of either **user** or **off**. When all four profile pulse modulators are set to *CW* mode in the Configuration Menu, the Setup Menu item **(PROFILE) MODE:** permits selection of either **cw** or **off**.

Table 3-3. Test Set Modulator Modes

Configuration Menu Modulator Setting	Setup Menu Mode Selections
STIMULUS MODULATOR: pulse	(STIMULUS) MODE: pulse or off
STIMULUS MODULATOR: cw	(STIMULUS) MODE: cw or off
PROFILE MODULATORS REF A: pulse REF B: pulse TEST A: pulse TEST B: pulse	(PROFILE) MODE: pulse or off
PROFILE MODULATORS REF A: pulse REF B: cw TEST A: pulse TEST B: cw	(PROFILE) MODE: user or off
PROFILE MODULATORS REF A: cw REF B: cw TEST A: cw TEST B: cw	(PROFILE) MODE: cw or off

Table 3-3 summarizes the available test set modulator mode settings and the resulting Setup Menu stimulus and profile mode selections.

b. Specifying the Pulse Generator Trigger Source

The menu item **PULSE GENERATOR TRIGGER SOURCE** allows you to specify whether the trigger source for the pulse generator is *internal* or *external*. The default setting is *internal*. To change the current pulse generator trigger source setting, proceed as follows:

1. Position the menu pointer (>) at **TRIGGER SOURCE:**
2. Press <ENTER> to select either **external** or **internal**.

c. Warning Messages

If you have not performed a calibration on the system since startup, the warning message – **SYSTEM UNCALIBRATED** – is displayed in red along the bottom of the Configuration Menu display. The warning message remains displayed until you perform a calibration from the Calibrate Menu, or until you recall a calibration from the File Utility Menu.

Once a calibration has been performed, if you change a pulse parameter that affects the duty cycle of either the stimulus or profile pulse, the warning message – **CAL MAY BE INVALID** – is displayed in red along the bottom of the Configuration Menu display. The pulse parameters that affect duty cycle are PRF, stimulus pulse width, and profile pulse width as well as the stimulus and profile mode settings.

d. Exiting the Menu

When you are finished with the Configuration Menu, you may exit using one of the following options:

- Press <ESC> to display the previous menu.
- Press function key F2 to display the Main Menu.
- Press function key F3 to display the Setup Menu.
- Press function key F4 to display the Calibrate Menu.

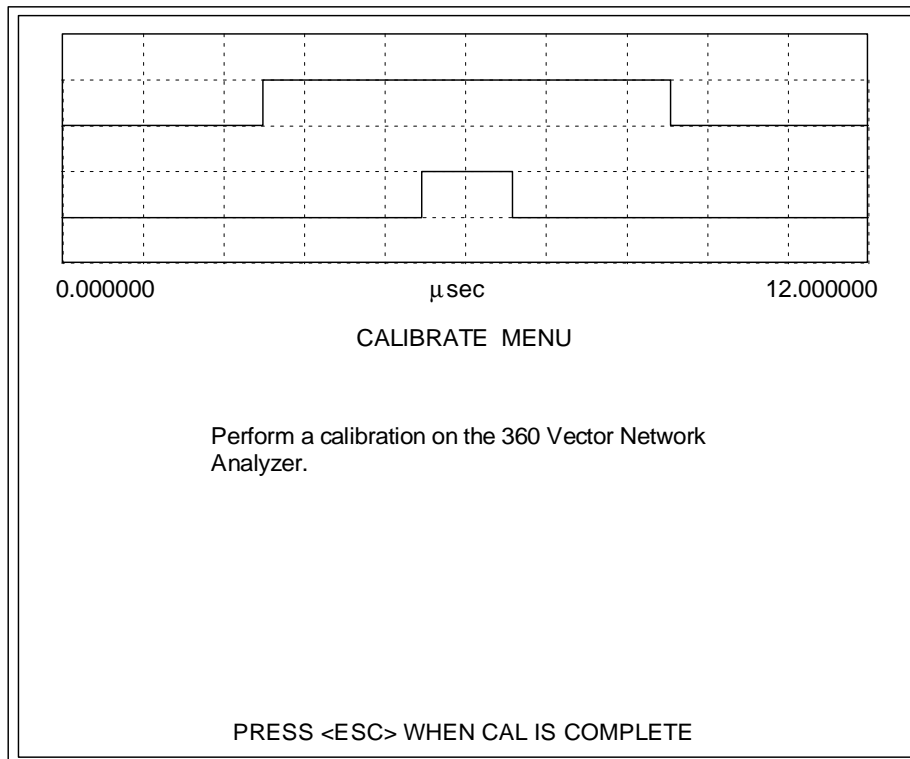

Figure 3-19. Calibrate Menu Display

3-6.7 Calibrating the 360 VNA System

The Calibrate Menu (Figure 3-19) prompts you to perform a calibration on the 360 VNA. The program places the VNA in local mode to let you manually calibrate it. Select the type of calibration required and perform the calibration steps as directed by the VNA. Refer to the Model 360 VNA Operation Manual for detailed calibration procedures.

There are two ways to display the Calibrate Menu. They are:

- From the Main Menu, select **CALIBRATE**, then press <ENTER>.
- From any menu of the pulse application program, press function key, F4.

The upper one-third of the Calibrate Menu display is a graphic simulation of the pulse generator stimulus and profile pulse outputs that are currently being applied to the test set stimulus and profile modulators. This simulation shows the relative width and position of the profile pulse in relation to the stimulus pulse.

a. *Selecting the Type of Calibration*

The types of S-Parameters measured for a single pulse profile measurement is determined by the type of VNA calibration performed and whether or not the correction is applied.

- If a 12-Term calibration is performed and correction applied, the pulse application program will measure all four S-Parameters (S_{11} , S_{12} , S_{21} , and S_{22}).
- If a 1 Path 2 Port calibration is performed and correction applied, the pulse application program will measure two S-Parameters, S_{11} and S_{21} .
- If a Frequency Response calibration is performed and correction applied, the pulse application program will measure the S-Parameters, S_{11} (Reflection), S_{21} (Transmission), or both S_{11} and S_{21} .
- If a Reflection Only calibration is performed and correction applied, the pulse application program will measure the S-Parameter, S_{11} .
- If no correction is applied, the pulse application program will measure all four S-Parameters (S_{11} , S_{12} , S_{21} , and S_{22}).

b. Warning Messages

If you have not performed a calibration on the system since startup, the warning message – **SYSTEM UNCALIBRATED** – is displayed in red along the bottom of the Calibrate Menu display. The warning message remains displayed until you perform a calibration.

Once a calibration has been performed, if you change a pulse parameter that affects the duty cycle of either the stimulus or profile pulse, the warning message – **CAL MAY BE INVALID** – is displayed in red along the bottom of the Calibrate Menu display. The pulse parameters that affect duty cycle are PRF, stimulus pulse width, and profile pulse width as well as the stimulus and profile mode settings.

If the Setup Menu pulse parameters cause the profile pulse to be positioned (delayed) outside of the stimulus pulse, the warning message – **PROFILE PULSE OUTSIDE STIMULUS PULSE** – is displayed in red near the center of the Calibrate Menu display.

If the Setup Menu item, **(STIMULUS) MODE:**, is set to **off**, the warning message – **STIMULUS PULSE IS OFF** – is displayed in red near the center of the Calibrate Menu display.

If the Setup Menu item, **(PROFILE) MODE:**, is set to **off**, the warning message – **PROFILE PULSE IS OFF** – is displayed in red near the center of the Calibrate Menu display.

If the Setup Menu items, **(STIMULUS) MODE:** and **(PROFILE) MODE:**, are both set to **off**, the warning message – **STIMULUS AND PROFILE PULSE ARE OFF** – is displayed in red near the center of the Calibrate Menu.

c. Saving/Recalling Calibration Data

You can save calibration data to a file on the computer/controller's hard disk or on a floppy disk. The calibration data that is saved to the file consists of the pulse parameters, the 360 VNA instrument state, and the 360 VNA calibration data. You can recall a previously saved calibration data file from the computer/controller's hard disk or a floppy disk. To save or recall a calibration data file:

1. Press function key F2 to display the Main Menu

2. Select menu item **FILE UTILITY**, then press <ENTER>
3. Proceed to paragraph 3-7 for procedures to save or recall a calibration data file.

d. Exiting the Menu

When you have finished calibrating the 360 VNA, there are several ways you can inform the pulse application program that calibration is complete while also returning the VNA to remote control. The options are:

- Press <ESC>, which also displays the previous menu.
- Press the function key, F2, which also displays the Main Menu.
- Press the function key, <Shift> F2, which also displays the Configuration Menu
- Press the function key, F3, which also displays the Setup Menu.
- Press the function key, F5, which also initiates a pulse profile measurement.

3-6.8 Performing a Pulse Profile Measurement

A pulse profile measurement can be performed only when the Setup Menu item, **MEAS MODE:**, is set to **pulse profile**. There are two ways you can initiate a pulse profile measurement sequence. They are:

- From the Main Menu, select **MEASURE**, then press <ENTER>.
- From any menu of the pulse application program, press function key, F5.

Once you initiate the measurement sequence, the pulse profile measurement display (Figure 3-20, page 3-32) is displayed on the computer/controller's monitor screen. The upper one-third of the display shows a graphic simulation of the profile pulse sweeping the stimulus pulse. The simulation illustrates the relative position of the profile pulse with respect to the stimulus pulse at each measurement point. Upon completion of the pulse profile measurement, a measurement data display with the Display Menu appears on the computer/controller's monitor screen. (Figure 3-21 on page 3-33)

You can terminate (abort) the pulse profile measurement at any time by pressing <ESC>.

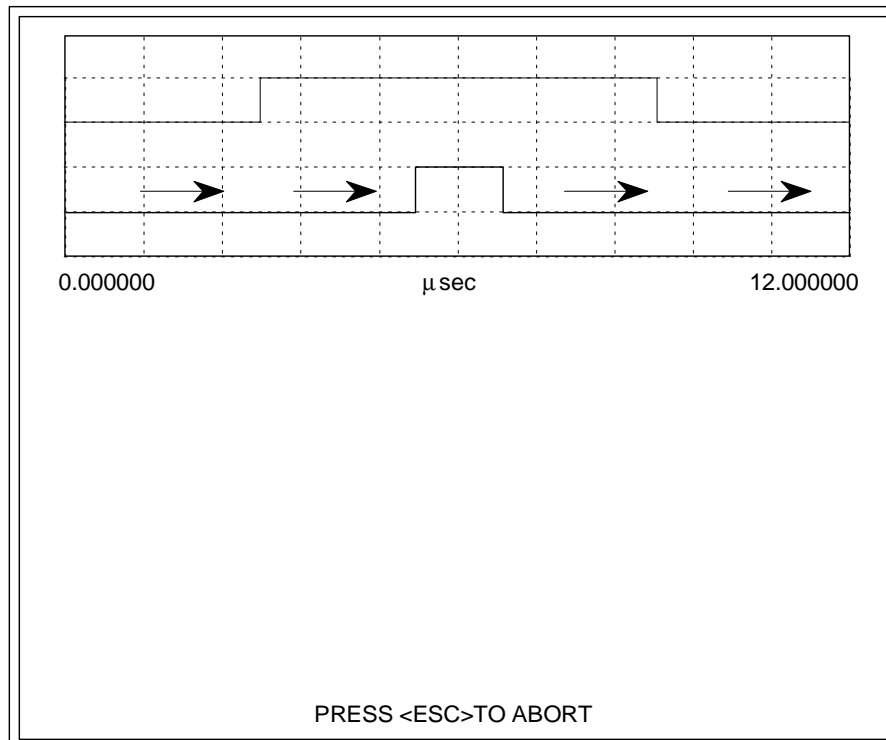

Figure 3-20. Display During a Pulse Profile Measurement

a. S-Parameter Measurements

The types of S-Parameters measured for a single pulse profile measurement are determined by the type of VNA calibration performed and whether or not the correction is applied. Refer to paragraph 3-6.7a for a listing relating the VNA calibrations to S-Parameter measurements.

b. Warning Messages

If you have not performed a calibration on the system since startup, the warning message – **SYSTEM UNCALIBRATED** – is displayed in red along the bottom of the display during the pulse profile measurement. The warning message is displayed each time you perform a pulse profile measurement until you perform a calibration from the Calibrate Menu, or until you recall a calibration from the File Utility Menu.

Once a calibration has been performed, if you change a pulse parameter that effects the duty cycle of either the stimulus or profile pulse, the warning message – **CAL MAY BE INVALID** – is displayed in red along the bottom of the display during the pulse profile measurement. The pulse parameters that affect duty cycle are PRF, stimulus pulse width, and profile pulse width as well as the stimulus and profile mode settings.

c. Saving/Recalling Measurement Data

You can save measurement data to a file on the computer/controller's hard disk or on a floppy disk. The measurement file contains data collected in one measurement sweep. Each file also contains the pertinent setup data (pulse parameters) associated with the measurement. You can recall a perviously saved measurement data file from the computer/controller's hard disk or a floppy disk. When recalled, the setup data stored in the measurement data file does not affect the setup of the system.

To save or recall a measurement data file:

1. Press function key F2 to display the Main Menu.
2. Select menu item **FILE UTILITY**, then press <ENTER>.
3. Proceed to paragraph 3-7 for procedures to save or recall a measurement data file.

3-6.9 Displaying the Measurement Data

Upon completion of a pulse profile measurement sequence, the measurement data is displayed immediately on the computer/controller's monitor screen. The display of pulse profile measurement data (Figure 3-21) is similar to the way data is displayed on

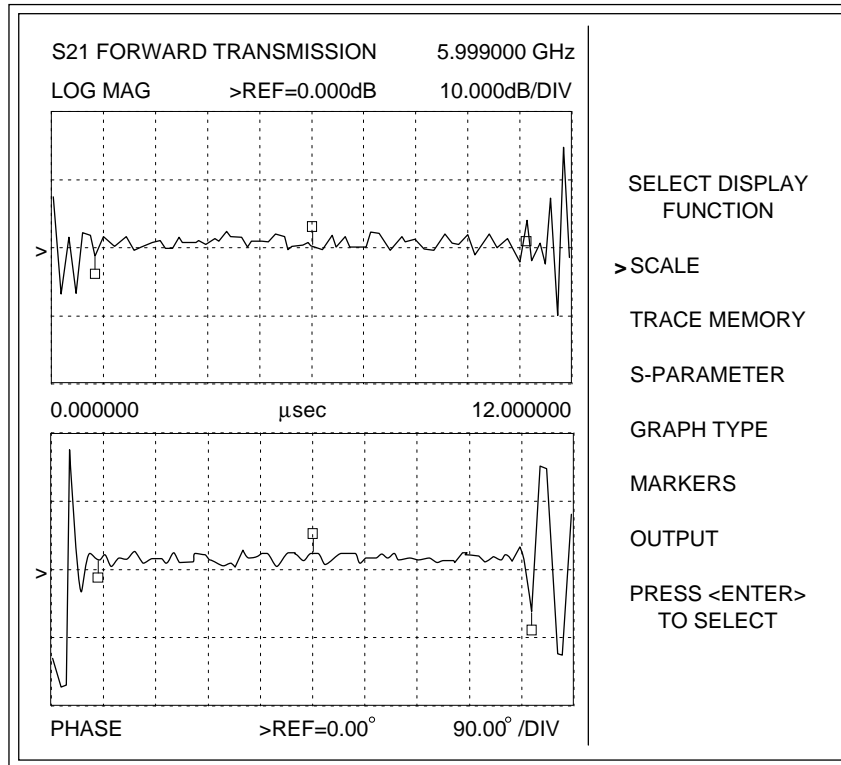

Figure 3-21. Data Display containing the Display Menu

the 360 VNA. The horizontal axis represents time (profile position) and the vertical axis represents either log mag, phase, real, or imaginary measurement data. The right-hand side of the display contains a menu of data display enhancement/control options.

You can also recall pulse profile measurement data for display from a previously saved measurement data file on the computer/controller's hard disk or a floppy disk. Follow the procedures given in paragraph 3-6.8c.

a. Exiting the Measurement Data Display

When you are finished with the measurement data display, you can exit using one of the following:

- Press <ESC> to return to the Main Menu.
- Press any of the following function keys:
 - F2 MAIN MENU
 - <Shift> F2 CONFIGURE
 - F3 SETUP MENU
 - F4 CALIBRATE
 - F5 MEASURE

3-6.10 Display Enhancements

The initial measurement data display (Figure 3-21) contains the Display Menu. This menu is a listing of

all available data display enhancement/control functions.

Once a pulse profile measurement has been made or recalled, you can access the data display containing the Display Menu from any menu in the pulse application program by pressing the function key, F6 DISPLAY MENU. If any pulse parameter is changed after the measurement data is taken, the measurement data is invalidated and you can not access the data display containing the Display Menu until a new pulse profile measurement is performed, or until the pulse parameters that were originally set for the measurement are restored.

a. Selecting a Function

You select a data display enhancement/control function from the Display Menu by positioning the menu pointer (>) adjacent to the function, then pressing <ENTER>. Move the menu pointer up and down with the ↑ and ↓ keys.

You also have the option to select certain menu functions using the dedicated function keys;

- F7 to select **SCALE MENU**.
- F9 to select **MARKER MENU**.
- F10 to select **OUTPUT MENU**.

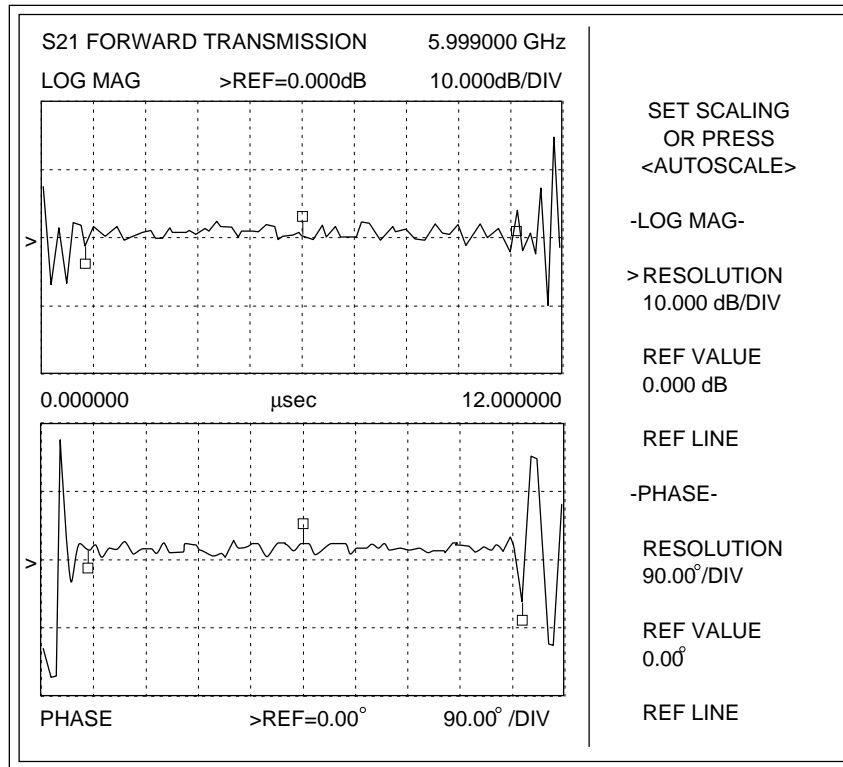

Figure 3-22. Data Display containing the Scale Menu

NOTE

Function keys, F7, F9, and F10, are only active when pulse profile measurement data is displayed on the computer/controller's monitor screen.

3-6.11 Setting the Data Display Scale Factors

You can set the data display scale factors using the Scale Menu (Figure 3-22). There are two ways you can access the measurement data display containing the Scale Menu. They are:

- From the data display containing the Display Menu, select the menu item **SCALE**, then press <ENTER>.
- From any pulse profile measurement data display, press function key, F7.

The Scale Menu allows you to enter the scale reference, resolution, and reference line position for the measurement data display.

a. Default Scale Factors

After startup, initial data displays are displayed using default scale factors. These scale factors remain active until (1) you enter new scale factor values via the Scale Menu or (2) you autoscale the data display by pressing the function key, F8.

The default scale factors are:

- For Log Magnitude data displays:
RESOLUTION: 10 dB/DIV
REF VALUE: 0 dB
- For Phase data displays:
RESOLUTION: 90 °/DIV
REF VALUE: 0°
- For Real and Imaginary data displays:
RESOLUTION: 10 U/DIV
REF VALUE: 0 ρU

b. Menu Selection and Data Entry

You select a menu item by positioning the menu pointer (>) adjacent to the item. Move the menu pointer with the ↑ and ↓ keys. Once you have selected a menu item, change scale values as follows:

- For Log Magnitude data displays, the unit of resolution is dB/DIV and unit of reference value is dB; for Phase data displays, the unit of resolution is °/DIV and the unit of reference value is °. To change the values of these menu items, select the item, type the new numeric value on the keyboard, then press <ENTER>.

- For Real and Imaginary data displays, the unit of resolution is U/DIV and the unit of reference value is U. To change the values of these menu items, select the item, type the new numeric value on the keyboard, then enter the appropriate terminator using the keyboard. The terminator choices are; p for picounits (ρ U), n for nanounits (nU), u for microunits (μ U), m for milliunits (mU), and <ENTER> for units (U).
- To set the reference line for the data display, select the menu item **REF LINE**, then use the ← and → keys on the keyboard to position the reference line (indicated by the cursor on the data display). Each time you press the ← or → key the reference line moves up or down one scale division.

The scale factors you set remain active until (1) you enter new scale factor values via the Scale Menu or (2) you autoscale the data display by pressing the function key, F8.

c. Range Error Message

Scale factors are checked for validity when you enter them. If you enter a value for a scale factor that is outside of the specified limits, an error message – **OUT OF RANGE** – is displayed in red at the bottom of the Scale Menu display.

The specified scale factor limits are as follows:

- For Log Magnitude data displays:
 - RESOLUTION:** 0.001 dB/DIV to 50.0 dB/DIV
 - REF VALUE:** -999.999 dB to 999.999 dB
- For Phase data displays:
 - RESOLUTION:** 0.01°/DIV to 90.0°/DIV
 - REF VALUE:** -180.0° to 180.0°
- For Real and Imaginary data displays:
 - RESOLUTION:** 1.0 ρ U/DIV to 999.999 U/DIV
 - REF VALUE:** -999.999U to 999.999U

d. Autoscale

Autoscaling adjusts the scaling factors of the data display so that approximately 80 per cent of the pulse profile measurement data is displayed. The new scaling factor values of reference and resolution are then displayed on the Scale Menu and the data display graticule. The scale factors set by the autoscaling remain active until you enter new scale factors via the Scale Menu.

To autoscale from any pulse profile measurement data display, press the function key, F8. The data display is then autoscaled for reference and resolution.

e. Exiting the Scale Menu

When you are finished with the Scale Menu, you can exit using one of the following methods:

- Press <ESC> to return to the data display containing the Display Menu.
- Press any one of the following function keys:
 - F2 MAIN MENU
 - <Shift> F2 CONFIGURE
 - F3 SETUP MENU
 - F4 CALIBRATE
 - F5 MEASURE
 - F6 DISPLAY MENU
 - F9 MARKER MENU
 - F10 OUTPUT MENU

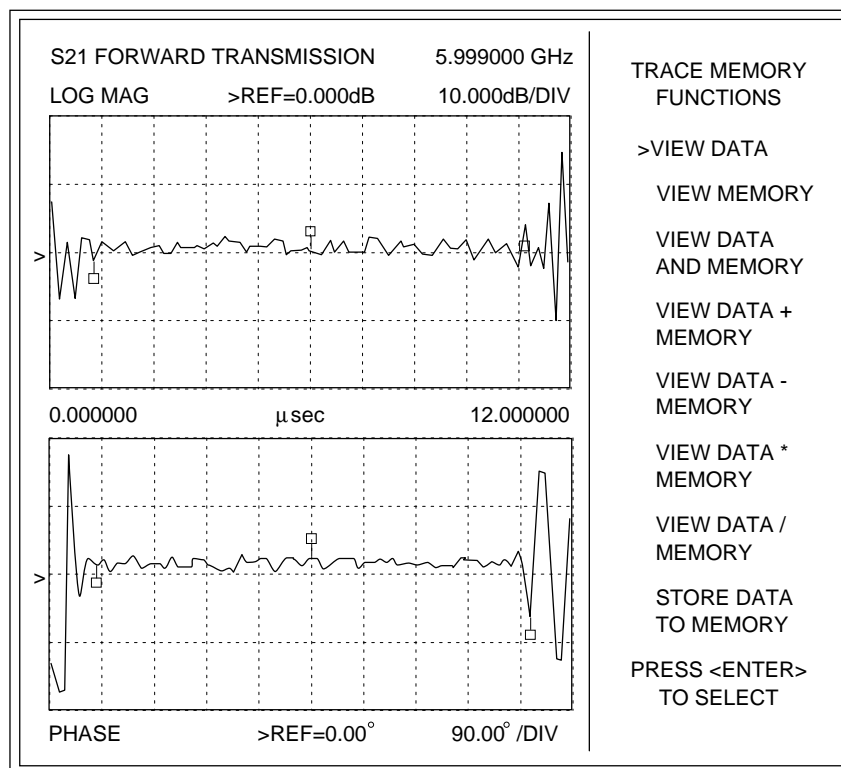

Figure 3-23. Data Display containing the Trace Memory Menu

3-6.12 Using Trace Memory

The pulse application program provides a trace memory that lets you store data for one S-Parameter. You gain access to trace memory via the Trace Memory Menu (Figure 3-23). The Trace Memory Menu lets you store pulse profile S-Parameter measurement data in memory, view memory data, view both active measurement data and memory data simultaneously, and perform mathematical operations with the memory data and measurement data. Only one trace memory exists; therefore, data for only one S-Parameter may be stored at a time.

You access the data display containing the Trace Memory Menu from the data display containing the Display Menu. To access the data display containing the Display Menu from any menu in the pulse application program, press function key F6 DISPLAY MENU. Select the Display Menu item **TRACE MEMORY**, then press <ENTER>.

a. Menu Selection

You select a Trace Memory menu item by positioning the menu pointer (>) adjacent to the item, then pressing <ENTER>. Move the menu pointer up and down with the ↑ and ↓ keys.

b. Trace Memory Functions

At the time of the first pulse profile measurement after startup, there is no data stored in trace memory. When you access the data display containing the Trace Memory Menu, the menu pointer points to **VIEW DATA**. If you wish to store the displayed pulse profile S-Parameter measurement data, select **STORE DATA TO MEMORY** and press <ENTER>.

Once pulse profile S-Parameter measurement data has been stored in memory, you can view it by selecting **VIEW MEMORY**, then pressing <ENTER>. The color green is used to display memory data in contrast to the active S-Parameter measurement data which is always displayed in red.

Suppose you wish to compare different pulse profile measurement data to the data stored in memory. After making the new measurement, you select **TRACE MEMORY** on the Display Menu to access the data display containing the Trace Memory Menu. Select menu item **VIEW DATA AND MEMORY**, then press <ENTER>. The active pulse profile S-Parameter measurement data (in red) and the memory data (in green) are both displayed on the data display.

If you wish to perform mathematical operations with the memory data, you can select from the menu items **VIEW DATA + MEMORY**, **VIEW DATA - MEMORY**, **VIEW DATA * MEMORY**, or **VIEW DATA / MEMORY**. The results of any one of these operations can also be stored in memory by selecting **STORE DATA TO MEMORY**, then pressing <ENTER>. You should be aware that this data will replace the existing memory data.

NOTE

Mathematical operations involving trace memory are *always* performed on the real and imaginary data. The results are then presented in the graph type selected for data display.

c. Error Messages

When there is no data stored in trace memory and you select any of the following Trace Memory Menu items; **VIEW MEMORY**, **VIEW DATA AND MEMORY**, **VIEW DATA + MEMORY**, **VIEW DATA - MEMORY**, **VIEW DATA * MEMORY**, or **VIEW DATA / MEMORY** and then press <ENTER>, the error message – **NO STORED MEMORY DATA** – is displayed in red at the bottom of the Trace Memory Menu display.

When you select the menu item **VIEW MEMORY** and press <ENTER>, the memory data is displayed on the data display. If you then select menu item **STORE DATA TO MEMORY** and press <ENTER>, the error message – **MEAS DATA NOT AVAILABLE FOR STORAGE** – is displayed in red at the bottom of the Trace Memory Menu display. You can *not* store memory data, only measurement data.

d. Exiting the Trace Memory Menu

When you are finished with the Trace Memory Menu, you can exit using one of the following methods:

- Press <ESC> to return to the data display containing the Display Menu.
- Press any one of the following function keys:
 - F2 MAIN MENU
 - <Shift> F2 CONFIGURE
 - F3 SETUP MENU
 - F4 CALIBRATE
 - F5 MEASURE
 - F6 DISPLAY MENU
 - F7 SCALE MENU
 - F9 MARKER MENU
 - F10 OUTPUT MENU

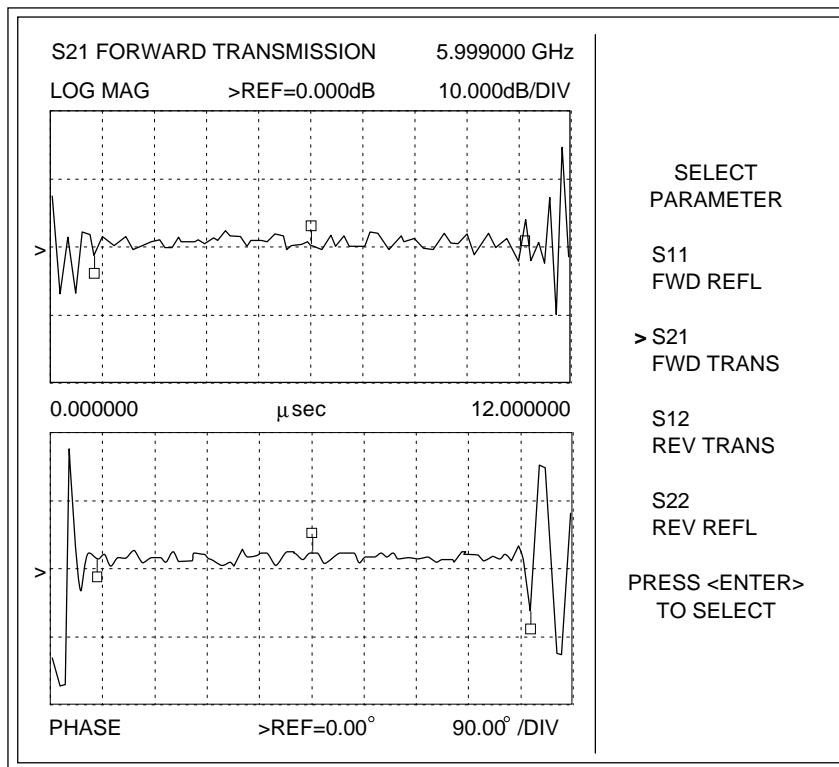

Figure 3-24. Data Display containing the S-Parameter Menu

3-6.13 Selecting S-Parameters for Display

You can select any of the measured S-Parameters for display using the S-Parameter Menu (Figure 3-24). You access the data display containing the S-Parameter Menu from the data display containing the Display Menu. To access the data display containing the Display Menu from any menu in the pulse application program, press function key F6 DISPLAY MENU. Select the Display Menu item **S-PARAMETER**, then press <ENTER>.

a. Menu Selection

You select a S-Parameter Menu item by positioning the menu pointer (>) adjacent to the item, then pressing <ENTER>. Move the menu pointer up and down with the ↑ and ↓ keys.

b. Availability of S-Parameters for Display

The types of S-Parameters measured by a single pulse profile measurement is determined by the type of correction applied. These are the only S-Parameter types that you can select for display. Upon completion of the pulse profile measurement, the initial data display (S-Parameter type and

graph type) is based upon program defaults for the type of correction applied. The following table lists the displayable S-Parameters and the initial (default) data display for each correction type.

Table 3-4. Display Types and Defaults by Correction Type

Correction Type	Displayable S-Parameters	Default Data Display
12-Term	S11, S12, S21, S22	S21 Log Mag & Phase
1-Path, 2-Port	S11, S21	S21 Log Mag & Phase
Frequency Response	S21 (Transmission)	S21 Log Mag & Phase
	S11 (Reflection)	S11 Real & Imaginary
	S11, S21 (Both)	S21 Log Mag & Phase
Reflection Only	S11	S11 Real & Imaginary
None	S11, S12, S21, S22	S21 Log Mag & Phase

c. S-Parameter Display Graph Types and Scale Factors

After startup, the initial data display for each type of S-Parameter is a dual display using the default graph types. The default graph types for the display of a particular S-Parameter type remains active until you select a different graph type using the Graph Type Menu (paragraph 3-6.14). The default graph types for display of the individual S-Parameter types are:

S₂₁ and S₁₂: Log Magnitude and Phase

S₁₁ and S₂₂: Real and Imaginary

The initial data display for each type of S-Parameter is displayed using default scale factors. These default scale factors for the display of a particular S-Parameter type remain active until (1) you enter new scale factor values via the Scale Menu (paragraph 3-6.11) or (2) you autoscale the data display by pressing the function key, F8.

The default scale factors are:

- For Log Magnitude data displays:

RESOLUTION: 10 dB/DIV

REF VALUE: 0 dB

- For Phase data displays:

RESOLUTION: 90 °/DIV

REF VALUE: 0°

- For Real and Imaginary data displays:

RESOLUTION: 10 U/DIV

REF VALUE: 0 ρU

The graph type you select and the scale factors you set for the display of a particular S-Parameter type remains active. Whenever you select that particular S-Parameter type again for display, data is displayed using the graph type last selected and scale factors last set.

d. No Data Error Message

If you select an S-Parameter type from the menu that has not been measured, the error message – **NO MEASURED S-PARAM DATA** – is displayed in red at the bottom of the S-Parameter Menu and the current S-Parameter displayed will not change.

e. Exiting the S-Parameter Menu

When you are finished with the S-Parameter Menu, you can exit using one of the following methods:

- Press <ESC> to return to the data display containing the Display Menu.
- Press any one of the following function keys:
 - F2 MAIN MENU
 - <Shift> F2 CONFIGURE
 - F3 SETUP MENU
 - F4 CALIBRATE
 - F5 MEASURE
 - F6 DISPLAY MENU
 - F7 SCALE MENU
 - F9 MARKER MENU
 - F10 OUTPUT MENU

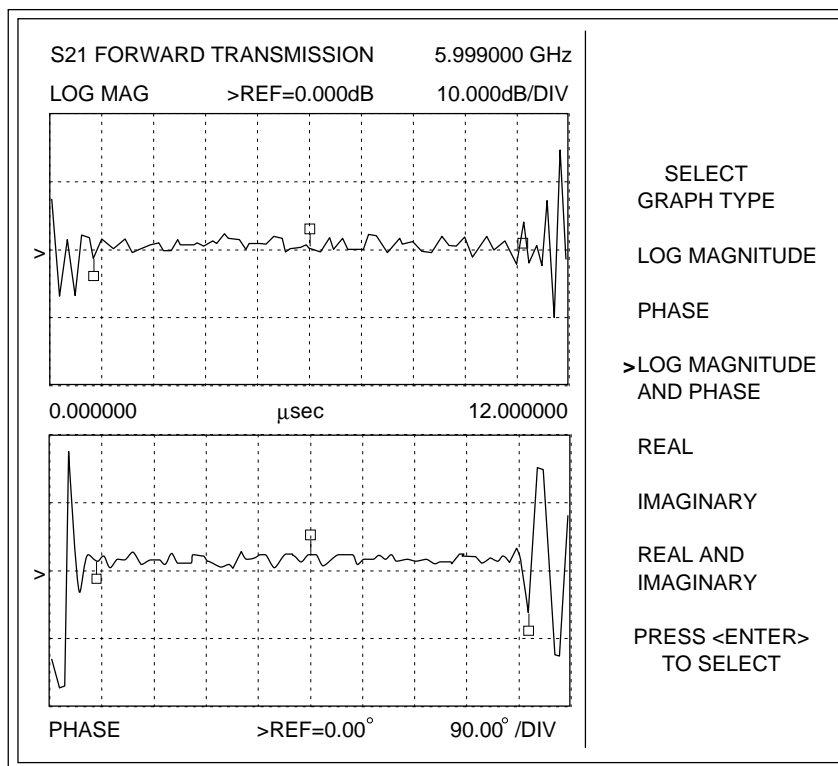

Figure 3-25. Data Display containing the Graph Type Menu

3-6.14 Selecting a Data Display Graph Type

S-Parameters can be displayed in either of two basic graph types, Log Magnitude and Phase or Real and Imaginary. You select the graph type for the data display of the selected S-Parameter from the Graph Type Menu (Figure 3-25). You access the data display containing the Graph Type Menu from the data display containing the Display Menu. To access the data display containing the Display Menu from any menu in the pulse application program, press function key F6 DISPLAY MENU. Select the Display Menu item **GRAPH TYPE**, then press <ENTER>.

a. Default Data Display Graph Types

After startup, the initial data display for each S-Parameter type is a default graph type display. The default display for a particular S-Parameter type remains active until you select a different graph type from the Graph Type Menu. The default graph types for display of the individual S-Parameter types are:

- S₂₁ and S₁₂:** Log Magnitude and Phase
- S₁₁ and S₂₂:** Real and Imaginary

b. Menu Selection

You select a menu item by positioning the menu pointer (>) adjacent to the item, then press <ENTER>. Move the menu pointer with the ↑ and ↓ keys.

You can choose either an individual graph type (Log Magnitude, Phase, Real, or Imaginary) display or a dual graph type (Log Magnitude and Phase or Real and Imaginary) display of the selected S-Parameter. The selected graph type display for each S-Parameter type remains active until you select a different graph type from the Graph Type Menu.

c. Exiting the Menu

When you are finished with the Graph Type Menu, you can exit using one of the following methods:

- Press <ESC> to return to the data display containing the Display Menu.
- Press any one of the following function keys:
 F2 MAIN MENU, <Shift>F2 CONFIGURE,
 F3 SETUP MENU, F4 CALIBRATE,
 F5 MEASURE, F6 DISPLAY MENU,
 F7 SCALE MENU, F9 MARKER MENU,
 F10 OUTPUT MENU.

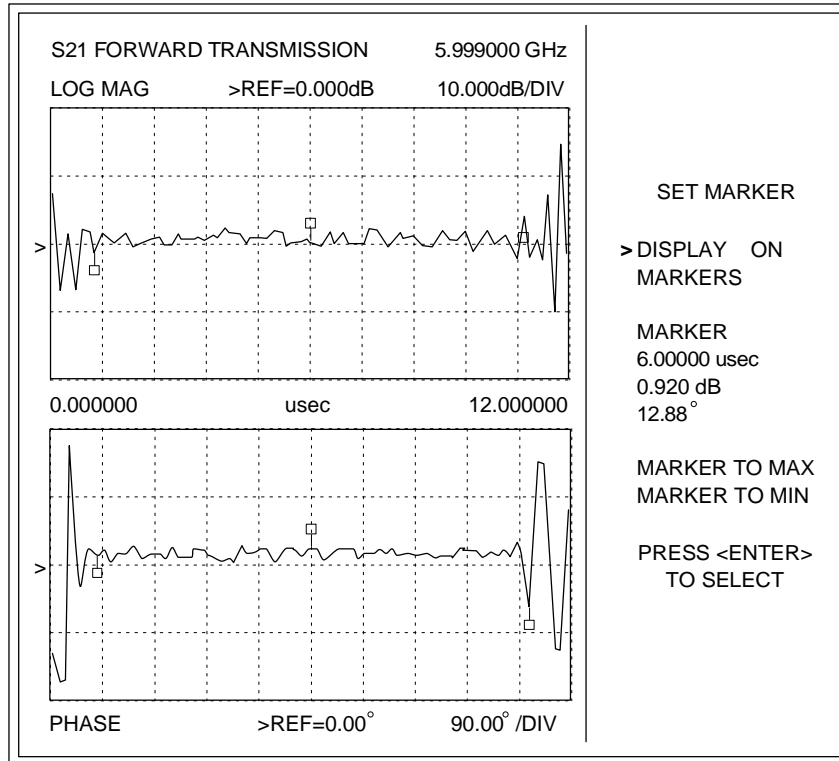

Figure 3-26. Data Display containing the Markers Menu

3-6.15 Displaying a Marker

You can display and control a single active marker using the Marker Menu (Figure 3-26). There are two ways you can access the data display containing the Marker Menu. They are:

- From the data display containing the Display Menu, select the menu item **MARKERS**, then press <ENTER>.
- From any pulse profile measurement data display, press function key, F9.

NOTE

If the marker display is off, selecting the menu item **MARKERS** or pressing the function key F9 turns the marker display on.

The Marker Menu lets you toggle the active marker display on and off, set the position of the active marker, and select the marker to maximum or minimum to establish the absolute maximum or minimum value of the displayed data. A blue box is used to display the active marker.

In addition, the display of the two inactive markers is turned on and off by the Marker Menu. These two yellow boxes indicate where the leading and trailing

edges of the stimulus pulse theoretically occur. These two markers are not moveable and are for reference only.

a. Menu Selection and Data Entry

You select a menu item by positioning the menu pointer (>) adjacent to the item, then pressing <ENTER>. Move the menu pointer with the ↑ and ↓ keys. The menu items are used as follows:

- Selecting **DISPLAY MARKERS ON (OFF)**, then pressing <ENTER> toggles the display of the markers on or off.
- Selecting **MARKER**, then pressing <ENTER> lets you position the active marker on the data display in one of two ways. (1) You can enter the time where you wish the marker to be positioned or (2) you can position the marker on the display by pressing the ← and → keys. The value of the display data at the marker's position is displayed on the menu in the measurement units for the graph type — dB for Log Magnitude, ° (degrees) for Phase, and U for Real and Imaginary.
- Selecting **MARKER TO MAX** or **MARKER TO MIN**, then pressing <ENTER> positions the active marker to the absolute maximum or minimum values of the displayed data. The maximum

or minimum value is displayed on the menu in the measurement units for the graph type. When the data is being displayed on a dual graph type display (Log Magnitude and Phase or Real and Imaginary), the maximum or minimum value displayed is for the top graph (Log Magnitude or Real) only.

b. Exiting the Marker Menu

When you are finished with the Marker Menu, you can exit using one of the following methods:

- Press <ESC> to return to the data display containing the Display Menu.
- Press any one of the following function keys:
 - F2 MAIN MENU
 - <Shift> F2 CONFIGURE
 - F3 SETUP MENU
 - F4 CALIBRATE
 - F5 MEASURE
 - F6 DISPLAY MENU
 - F7 SCALE MENU
 - F10 OUTPUT MENU

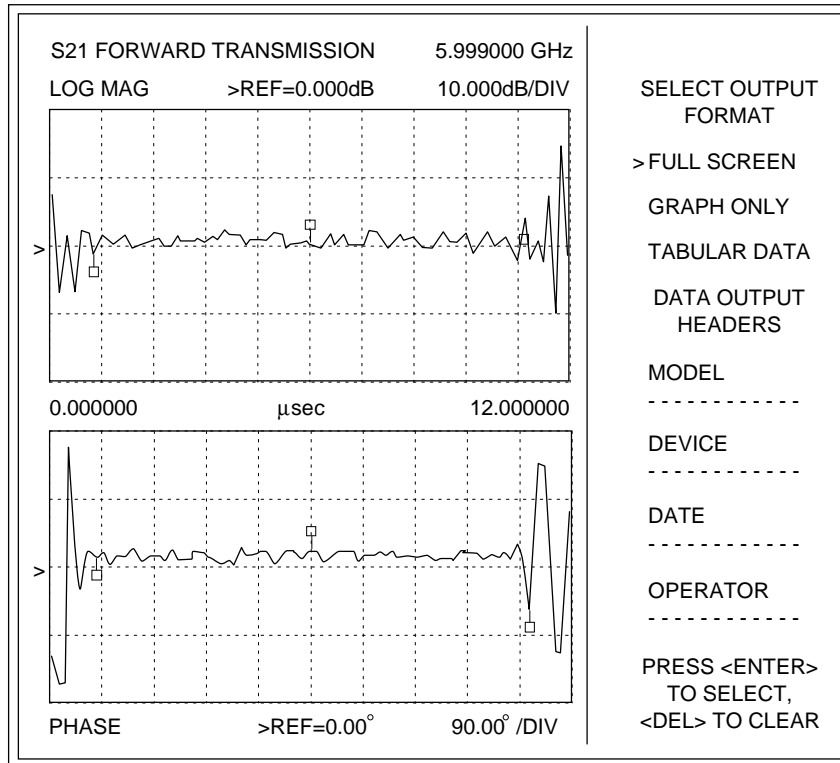

Figure 3-27. Data Display containing the Output Menu

3-6.16 Printing Out Measurement Data

The Output Menu (Figure 3-27) lets you select one of three formats for the pulse profile measurement data printouts – Full Screen, Graph Only, and Tabular Data. In addition, it lets you add data header information to the printouts. There are two ways you can access the data display containing the Output Menu. They are:

- From the data display containing the Display Menu, select the menu item **OUTPUT**, then press <ENTER>.
- From any pulse profile measurement data display, press function key, F10.

a. Menu Selection and Data Entry

You can select a menu item by positioning the menu pointer (>) adjacent to the item. Move the menu pointer with the ↑ and ↓ keys.

- For **SELECT OUTPUT FORMAT** menu items, once you have selected a menu item, press <ENTER>.
- For **DATA OUTPUT HEADERS** menu items, once you have selected a menu item, type in the data header information (1 to 12 characters), then either press <ENTER> or move the menu

pointer to the next item. (Moving the menu pointer to the next item will cause the data you have input to be automatically entered.)

The defaults are Full Screen output format with the current date entered in the Data Output Headers **DATE** field.

b. Deleting Data Entries

You can clear a data entry from a Data Output Headers field by selecting the menu item, then pressing the key on the keyboard.

NOTE

When there is no data entered in any of the Data Output Headers fields, the pulse profile measurement data printouts will not contain any header information.

c. Printout Descriptions

The following are descriptions of the format of the three types of measurement data printouts you can select from the Output Menu. Examples of each type printout are also provided.

FULL SCREEN – prints out a tabular listing of the pulse parameters and the full screen data display of the pulse profile measurement data, including the menu items on the right hand side of the data dis-

play. Figure 3-28 is an example of a full screen printout.

GRAPH ONLY – prints out a tabular listing of the pulse parameters and the graph only data display of the pulse profile measurement data, including any and all data the graph contains. The menu items on the right hand side of the data display are not included. Figure 3-29 is an example of a graph only printout.

TABULAR DATA – prints out a tabular listing of the pulse parameters and a tabulation of the pulse profile measurement data. Figure 3-30 is an example of a tabular data printout.

d. Initiating a Printout

Once you have specified the format for the pulse profile measurement data output to the printer using the Output Menu, you can initiate the printout from any pulse profile measurement data display by pressing the function key, <Shift> F10.

e. Stop Print

Once printing has started, you can abort the printing of the pulse profile measurement data by pressing <Ctrl> Break.

f. Exiting the Output Menu

When you are finished with the Output Menu, you can exit using one of the following methods:

- Press <ESC> to return to the data display containing the Display Menu.
- Press any one of the following function keys:
 - F2 MAIN MENU
 - <Shift> F2 CONFIGURE
 - F3 SETUP MENU
 - F4 CALIBRATE
 - F5 MEASURE
 - F6 DISPLAY MENU
 - F7 SCALE MENU
 - F9 MARKER MENU

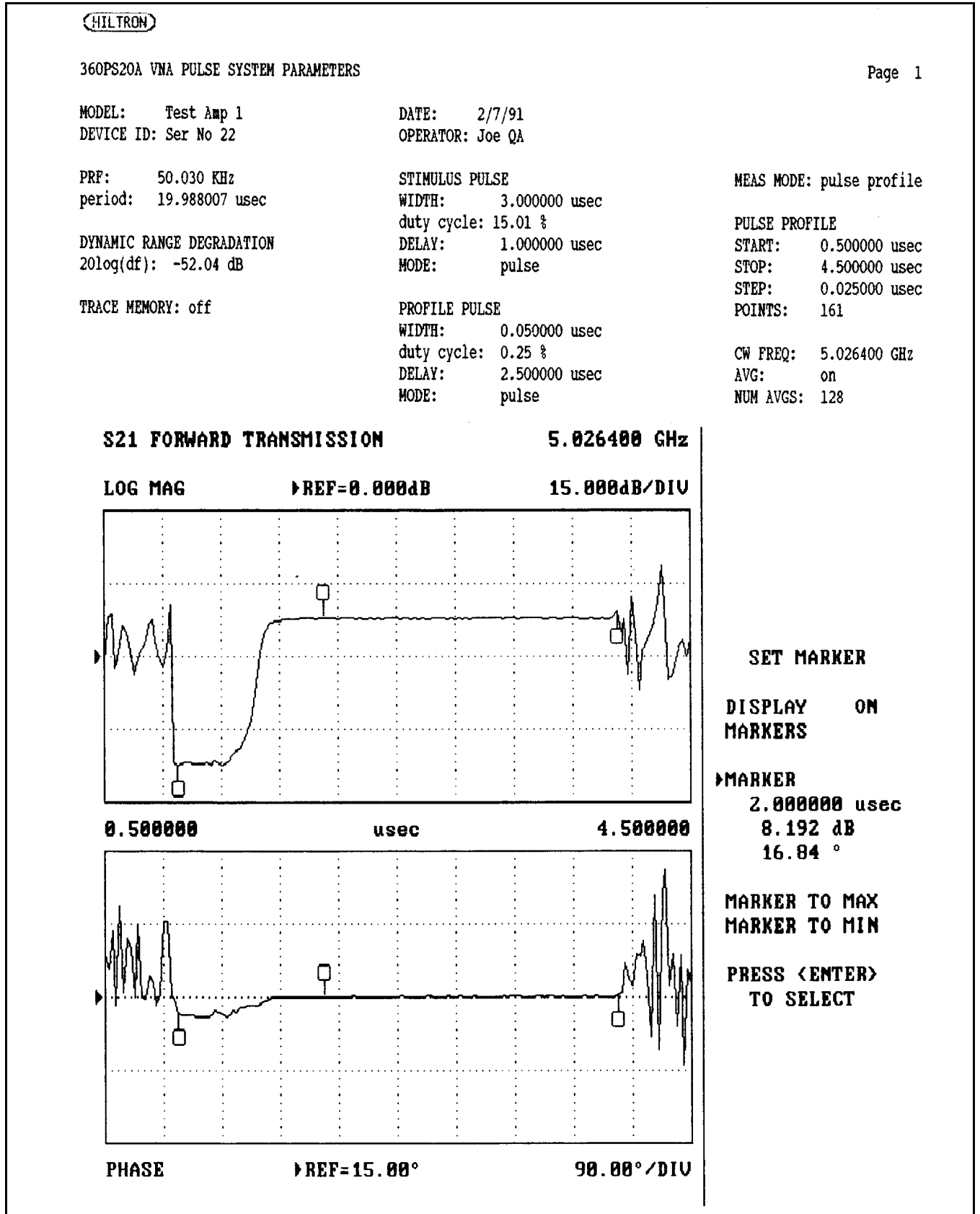

Figure 3-28. Example of a Full Screen Data Printout

WILTRON

360PS20A VNA PULSE SYSTEM PARAMETERS

Page 1

PRF: 10.000 KHz
 period: 100.000000 usec

DYNAMIC RANGE DEGRADATION
 20log(df): -46.02 dB

TRACE MEMORY: off

STIMULUS PULSE
 WIDTH: 10.000000 usec
 duty cycle: 10.00 %
 DELAY: 1.000000 usec
 MODE: pulse

PROFILE PULSE
 WIDTH: 0.500000 usec
 duty cycle: 0.50 %
 DELAY: 5.750000 usec
 MODE: pulse

MEAS MODE: pulse profile

PULSE PROFILE
 START: 0.000000 usec
 STOP: 12.000000 usec
 STEP: 0.150000 usec
 POINTS: 81

CWFREQ: 20.000000 GHz
 AVG: off
 NUM AVGS: 128

S21 FORWARD TRANSMISSION

20.000000 GHz

LOG MAG

▶ REF=0.000dB

10.000dB/DIV

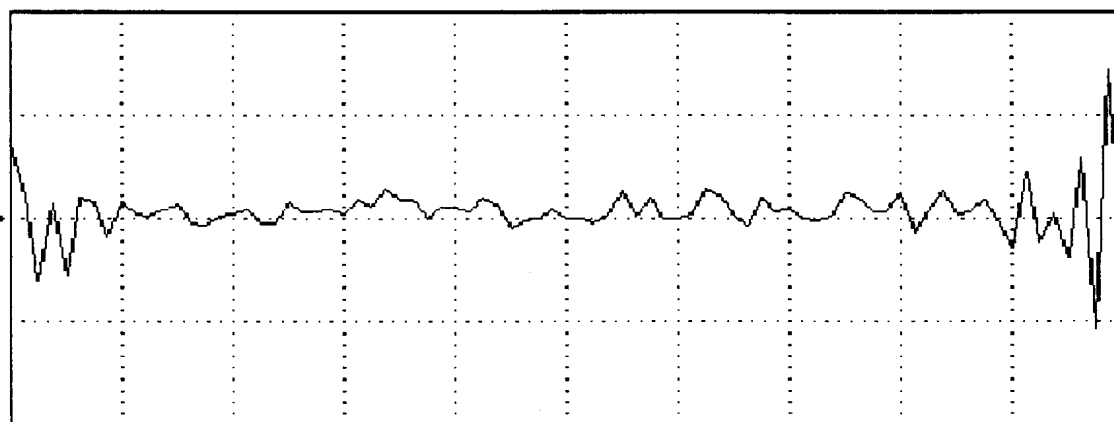

0.000000

usec

12.000000

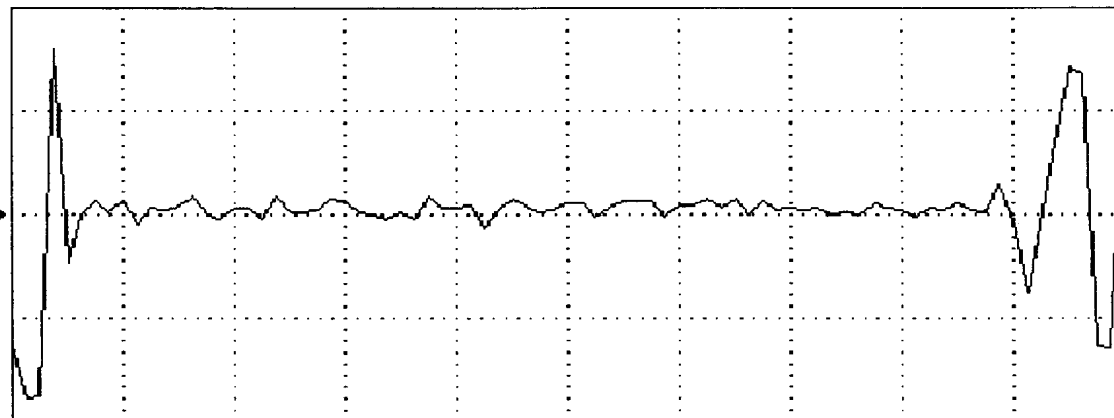

PHASE

▶ REF=0.00°

90.00°/DIV

Figure 3-29. Example of a Graph Only Data Printout

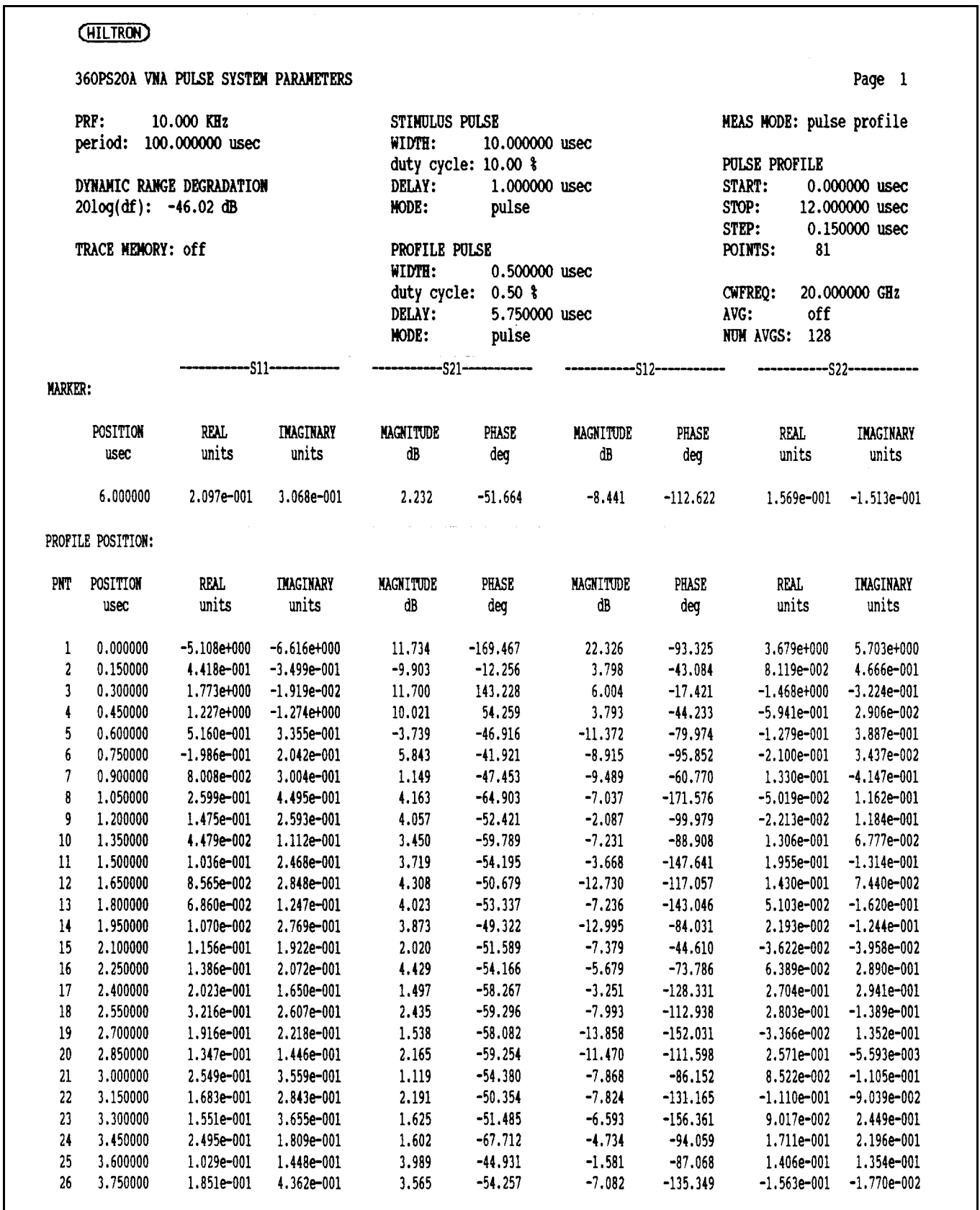

Figure 3-30. Example of a Tabular Data Printout

3-7 FILE UTILITIES

The File Utility module, a component of the pulse application program, gives you the following capabilities:

- To save system calibrations, setup configurations, and measurement data as files on either the computer/controller's hard disk or a floppy disk in disk drive A or B.
- To recall the saved files whenever required.
- To perform the basic file operations of delete, copy, rename, and list directory.

The module also performs error handling and reporting for DOS system, GPIB, and pulse application program errors.

3-7.1 File Types

The File Utility module generates three file types for storing the system calibration, setup configuration, and measurement data. The file types are:

- **Calibration Files** – The calibration files contain the pulse parameters, the 360 VNA instrument state, and the 360 VNA calibration data. The calibration files are identified by the file extension, **.CAL**.
- **Setup Files** – The setup files contain the pulse parameters and the 360 VNA instrument state. The setup files are identified by the file extension, **.STP**.
- **Measurement Files** – The measurement files contain data collected in one measurement sweep. Each file also contains the 360CC setup data (pulse parameters) associated with the measurement. When recalled, the setup data stored here does not affect the setup of the system. The measurement files are identified by the file extension, **.MES**.

3-7.2 File Storage

Once generated by the File Utility module, the calibration and setup files are saved either on the computer/controller's hard disk, designated **HD**, or on a floppy disk using one of the computer/controller's two disk drives, designated **A** and **B**.

NOTE

The following menu item/option selection and data entry procedures apply to all file operation menus.

3-7.3 Menu Item/Option Selection and Data Entry

Select menu items and options and enter data using the following procedures:

- Select a menu item by positioning the menu pointer (>) adjacent to the item. Move the menu pointer with the ↑ and ↓ keys.
- For the menu items that contain options (**FILE TYPE: Calibration / Setup / Measurement** and **DRIVE NAME: HD / A / B**), select the desired option using the ← and → keys. When selected, the color of the selected option changes.
- To enter data for the menu item **FILE NAME:**, type in the file name following DOS naming conventions. The file name should consist of from one to eight characters with no spaces between them. The file extension, **.CAL**, **.STP**, or **.MES**, is automatically appended to the file name based on your **FILE TYPE:** option selection.

NOTE

If a file name is required for a particular operation, it must be entered before the operation can be executed.

When you have finished making your menu selections and have entered any required file names, press <ENTER> to perform the file operation.

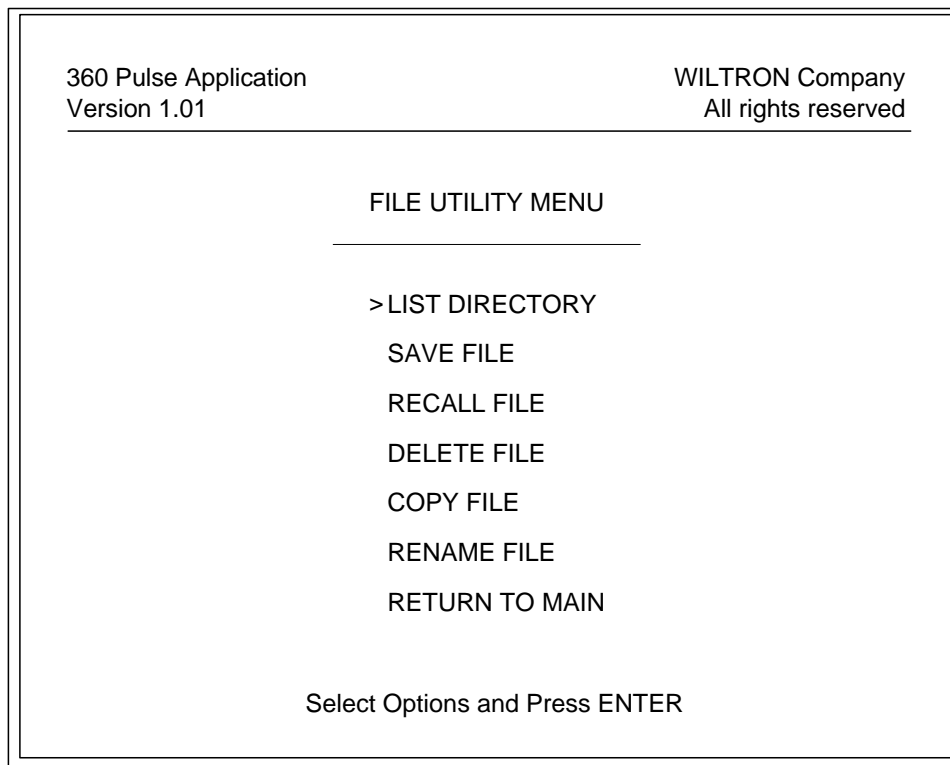

Figure 3-31. File Utility Menu Display

NOTE

When the File Utility module program is running, the dedicated function keys of the pulse application program can **not** be activated.

3-7.4 File Utility Menu

Selecting the Main Menu item **FILE UTILITY** executes the File Utility module, displaying the File Utility Menu (Figure 3-31). The File Utility Menu provides you with access to each of the file operations necessary for generating and managing the calibration and setup files.

a. Selecting a Menu Item

You can select a menu item by positioning the menu pointer (>) adjacent to the item, then pressing <ENTER>. Move the menu pointer with the ↑ and ↓ keys.

Selecting any one of the menu items, with the exception of **RETURN TO MAIN**, produces the menu display for that particular file operation. Menu displays and procedures for performing each file operation are provided on the following pages.

b. Exiting the File Utility Menu

When you are finished performing file operations, you can terminate the execution of the File Utility module and return to the Main Menu display of the pulse application program using either of the following methods:

- Select the menu item, **RETURN TO MAIN**, then press <ENTER>.
- Press <ESC>.

NOTE

You can **not** exit from any of the File Utility menus to any of the pulse application program menus except as described above.

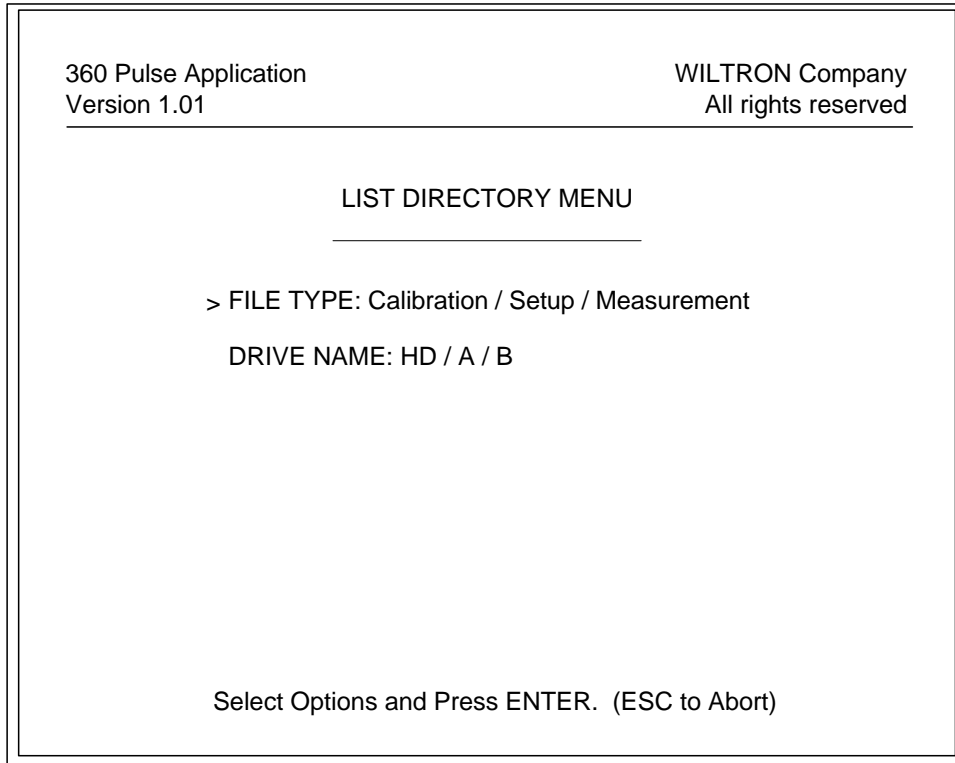

Figure 3-32. List Directory Menu Display

3-7.5 Listing the Files

You list the files in a file directory using the List Directory Menu (Figure 3-32). There are three file directories, one for each file type. To display the List Directory Menu, select the File Utility Menu item, **LIST DIRECTORY**, then press <ENTER>.

a. Listing a Directory

To list a directory, proceed as follows:

1. Select the directory file type (Calibration, Setup, or Measurement).
2. Select the drive where the files are stored (hard disk or floppy disk drive A or B).
3. Press <ENTER>.

The directory list of the selected file type is then displayed.

b. Aborting the Operation or Exiting the Menu

To abort the listing of the file directory or to exit the List Directory Menu, press <ESC>. The program returns you to the File Utility Menu display.

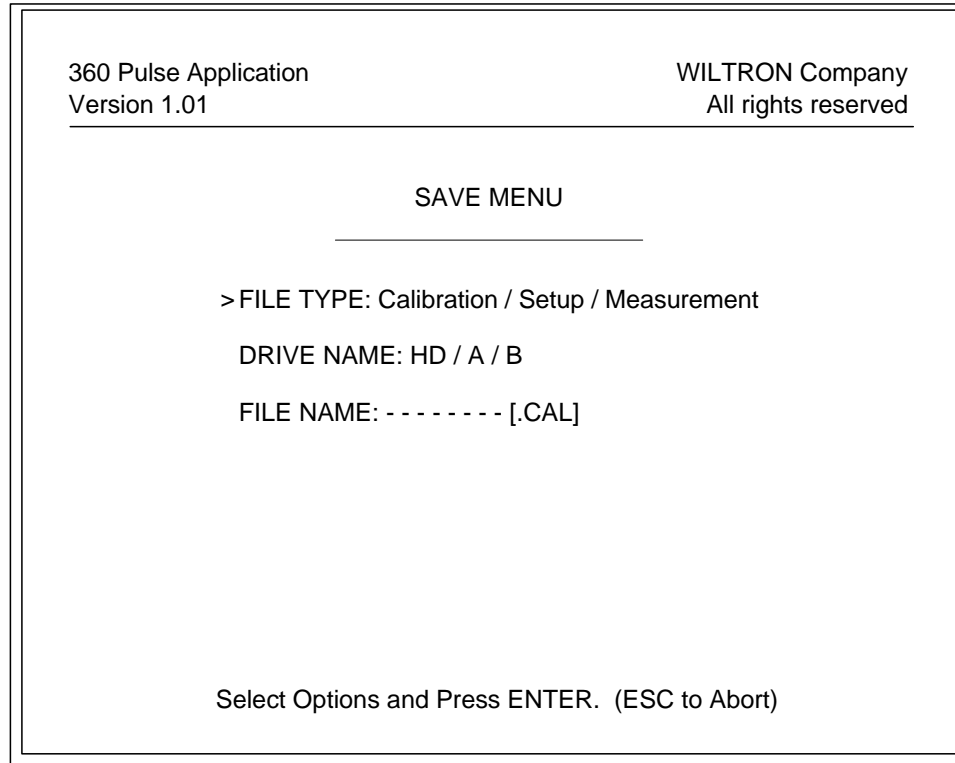

Figure 3-33. Save Menu Display

3-7.6 Saving Calibration, Setup, and Measurement Data Files

You can save system calibration data, setup configuration data, and measurement data to files using the Save Menu (Figure 3-33). To display the Save Menu, select the File Utility Menu item, **SAVE FILE**, then press <ENTER>.

a. Saving a File

To save a file, proceed as follows:

1. Select the file type (Calibration, Setup, or Measurement).
2. Select the drive where the file is to be stored (hard disk or floppy disk drive A or B).
3. Enter a name for the file.
4. Press <ENTER>.

NOTE

Steps 1 thru 3 can be performed in any order.

The file is generated and saved to the selected disk.

b. Aborting the Operation or Exiting the Menu

If you wish to abort the file operation or to exit the Save Menu, press <ESC>. The program returns you to the File Utility Menu display.

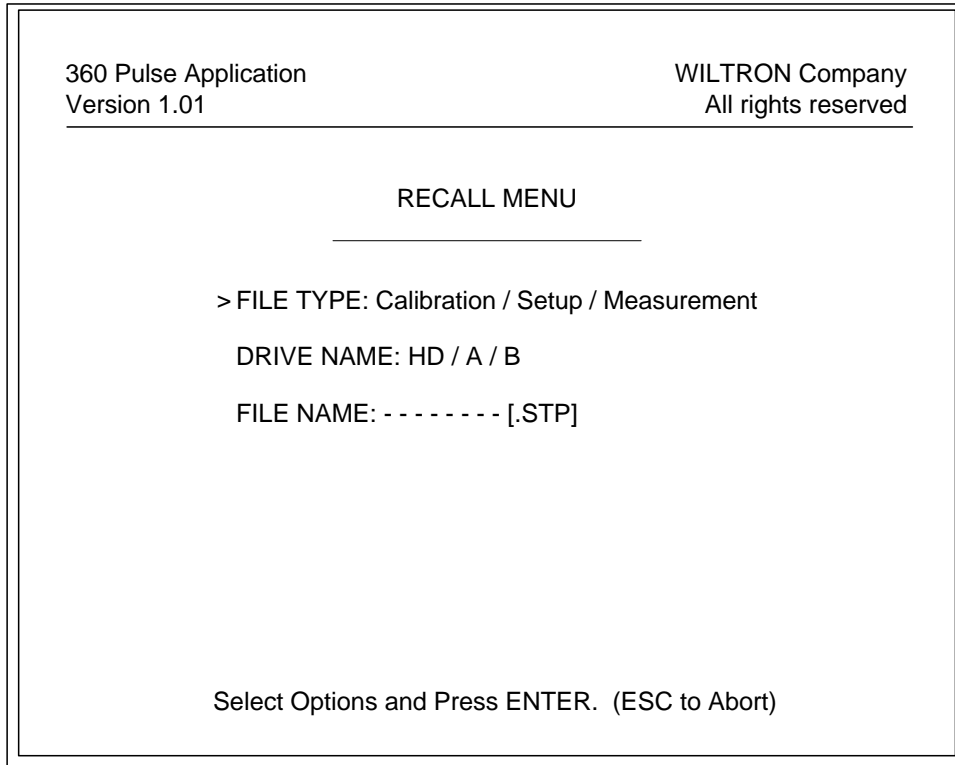

Figure 3-34. Recall Menu Display

3-7.7 Recalling Calibration, Setup, and Measurement Files

You can recall system calibrations, setup configurations, and measurement data previously saved as files from the hard disk or a floppy disk using the Recall Menu (Figure 3-34). To display the Recall Menu, select the File Utility Menu item, **RECALL FILE**, then press <ENTER>.

a. Recalling a File

To recall a file, proceed as follows:

1. Select the file type (Calibration, Setup, or Measurement).
2. Select the drive where the file is stored (hard disk or floppy disk on drive A or B).
3. Enter the name of the file.
4. Press <ENTER>.

NOTE

Steps 1 thru 3 can be performed in any order.

The selected calibration, setup, or measurement file will be recalled and the data applied to the system.

NOTE

The data stored in the selected measurement file is **only** available for display, and does not affect the setup of the system.

b. Aborting the Operation or Exiting the Menu

If you wish to abort the file operation or to exit the Recall Menu, press <ESC>. The program returns you to the File Utility Menu display.

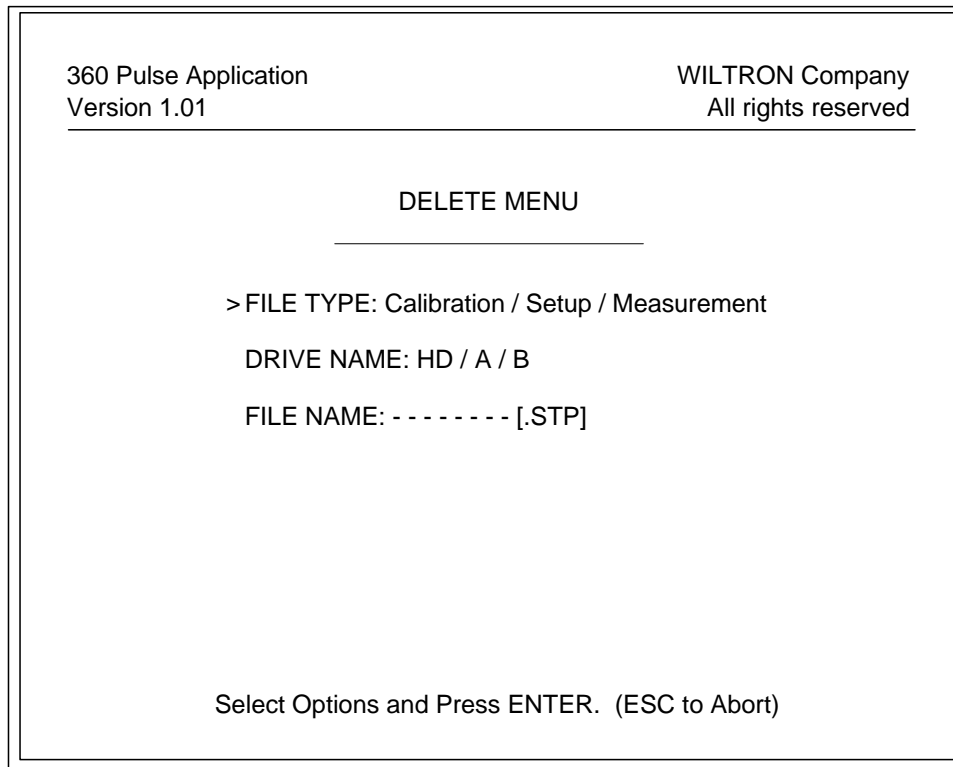

Figure 3-35. Delete Menu Display

3-7.8 Deleting Calibration, Setup, and Measurement Files

You can delete calibration, setup, and measurement files from the hard disk or a floppy disk using the Delete Menu (Figure 3-35). To display the Delete Menu, select the File Utility Menu item, **DELETE FILE**, then press <ENTER>.

a. Deleting a File

To delete a file, proceed as follows:

1. Select the file type (Calibration, Setup, or Measurement).
2. Select the drive where the file is stored (hard disk or floppy disk on drive A or B).
3. Enter the name of the file.
4. Press <ENTER>.

NOTE

Steps 1 thru 3 can be performed in any order.

The selected calibration or setup file is deleted.

b. Aborting the Operation or Exiting the Menu

If you wish to abort the file operation or to exit the Delete Menu, press <ESC>. The program returns you to the File Utility Menu display.

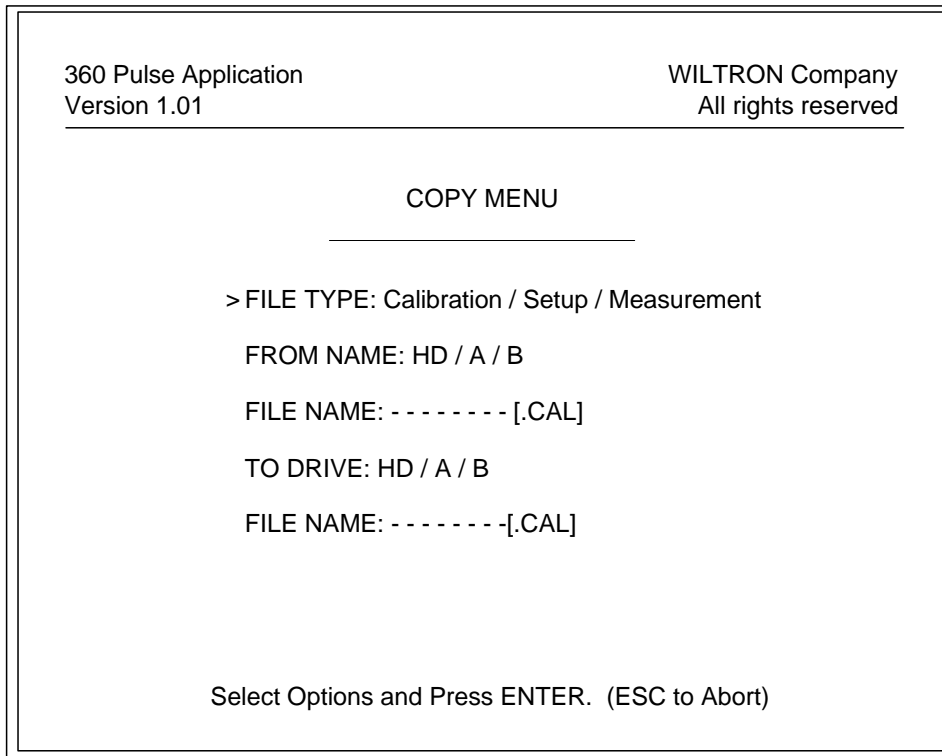

Figure 3-36. Copy Menu Display

3-7.9 Copying Calibration, Setup, and Measurement Files

You can copy calibration, setup, and measurement files or directories from one storage device to another using the Copy Menu (Figure 3-36). To display the Copy Menu, select the File Utility Menu item, **COPY FILE**, then press <ENTER>.

a. Copying a File

To copy a file, proceed as follows:

1. Select the file type (Calibration, Setup, or Measurement).
2. Select the drive where the file is stored (hard disk or floppy disk drive A or B).
3. Enter the name of the file to be copied.
4. Select the destination drive where the file is to be stored.
5. Enter the destination file name. (You may use * if you wish to retain the same file name.)
6. Press <ENTER>.

NOTE

Steps 1 thru 5 can be performed in any order.

The selected calibration, setup, or measurement file is copied.

b. Copying a Directory

If you wish to copy an entire directory, proceed as follows:

1. Select the directory file type (Calibration, Setup, or Measurement).
2. Select the drive where the directory is stored.
3. For **FROM FILE:**, enter * .
4. Select the destination drive.
5. For **TO FILE:**, enter * .
6. Press <ENTER>.

The selected calibration, setup, or measurement file directory is copied.

c. Aborting the Operation or Exiting the Menu

If you wish to abort the file operation or to exit the Copy Menu, press <ESC>. The program returns you to the File Utility Menu display.

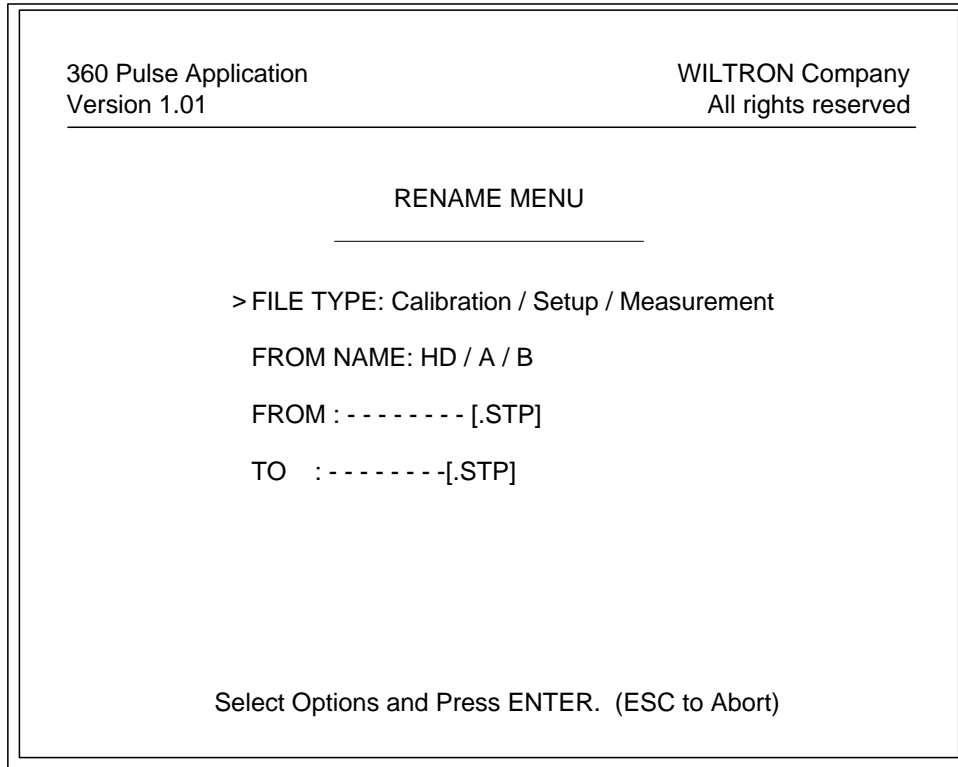

Figure 3-37. Rename Menu Display

3-7.10 Renaming Calibration, Setup, and Measurement Files

You can rename a calibration, setup, or measurement file using the Rename Menu (Figure 3-37). You can only rename a file to its own type; a setup file can *not* be renamed as a calibration file and vice versa. To display the Rename Menu, select the File Utility Menu item, **RENAME FILE**, then press <ENTER>.

a. Renaming a File

To rename a file, proceed as follows:

1. Select the file type (Calibration, Setup, or Measurement).
2. Select the drive where the file is stored (hard disk or floppy disk drive A or B).
3. Enter the name of the file to be renamed.
4. Enter the new name for the file.
5. Press <ENTER>.

The selected calibration, setup, or measurement file is renamed.

b. Aborting the Operation or Exiting the Menu

If you wish to abort the file operation or to exit the Rename Menu, press <ESC>. The program returns you to the File Utility Menu.

3-8 ERROR AND WARNING MESSAGES

During setup, calibration, pulsed profile measurement, and display of the measurement data, the pulse application program generates error messages to indicate invalid data entries and improper menu selections by the operator. In addition, the program produces warning messages to alert the operator to conditions that could result in inaccurate pulsed measurements.

3-8.1 Error Messages

The following are the error messages that are generated by the program during the pulsed measurement process. In addition to a description of what caused the error message to be displayed, the operator action necessary to clear the error condition is also described.

- **INVALID PARAMETER** – When you enter a pulse parameter on the Setup Menu that is outside the specified limits, this error message is displayed in red along the bottom of the Setup Menu display. The invalid pulse parameter is also displayed in red. The menu pointer remains fixed at the invalid item and continues to remain inactive as long as the pulse parameter is invalid. To reactivate the menu pointer, you can enter a valid pulse parameter or press <ESC> to restore the previous value of the out-of-range parameter.
- **CONFLICTING PARAMETERS** – If you enter a pulse parameter on the Setup Menu that results in conflicting pulse parameters, this error message is displayed in red along the bottom of the Setup Menu display. The conflicting pulse parameters are also displayed in red. The menu pointer remains active while the error message is displayed allowing you to modify any pulse parameter, but you can *not* exit the Setup Menu while the error message is displayed. An example of conflicting parameters is a stimulus pulse width that exceeds the period. In this case, both the PRF and the stimulus pulse width parameters would be displayed in red. Once you enter valid, non-conflicting pulse parameters, the error message clears.
- **OUT OF RANGE** – This error message is displayed in red at the bottom of the Scale Menu when you try to enter a data display scale factor that is outside the specified limits. Entering a valid scale factor clears the error message.
- **NO STORED MEMORY DATA** – If there is no data stored in trace memory, selecting any of the view memory menu items from the Trace Memory Menu, then pressing <ENTER> results in this error message. The error message is displayed in red at the bottom of the Trace Memory Menu. Selecting the menu item **VIEW DATA**, then pressing <ENTER> clears the error message.
- **MEAS DATA NOT AVAILABLE FOR STORAGE** – If you are viewing trace memory data on the display, selecting the Trace Memory menu item **STORE DATA TO MEMORY**, then pressing <ENTER> results in this error message. The error message is displayed in red at the bottom of the Trace Memory Menu You can *not* store memory data, only measurement data. Selecting any of the view menu items, then pressing <ENTER> clears the error message.
- **NO MEASURED S-PARAM DATA** – This error message is displayed in red at the bottom of the S-Parameter Menu whenever you select an S-Parameter type from the menu that has not been measured and press <ENTER>. The current S-Parameter data display will not change. To clear the error message, move the menu pointer to another menu item.

3-8.2 Warning Messages

The following are the warning messages that are produced by the program during the pulsed measurement process. They alert the operator to the condition described:

- **SYSTEM UNCALIBRATED** – If you have not performed a calibration on the system since startup, this warning message is displayed in red along the bottom of all displays (except for measurement data displays). The warning message remains until you perform a calibration from the Calibrate Menu, or until you recall a calibration from the File Utility Menu.
- **CAL MAY BE INVALID** – Once a system calibration has been performed, if you change a pulse parameter that affects the duty cycle of either the stimulus or profile pulse, this warning message is displayed in red along the bottom of all displays (except for measurement data displays). The pulse parameters that affect duty cycle are PRF, stimulus pulse width, and profile pulse width as well as the stimulus and profile mode settings. This warning message will stay displayed until you perform a new system calibration.

- **PROFILE PULSE OUTSIDE STIMULUS PULSE** – This warning message is displayed in red near the center of the Calibrate Menu display when the Setup Menu pulse parameters cause the profile pulse to be positioned (delayed) outside of the stimulus pulse. To clear the warning message, change the Setup Menu pulse parameter entries to position the profile pulse within the stimulus pulse.
- **STIMULUS PULSE IS OFF** – This warning message is displayed in red near the center of the Calibrate Menu display if the Setup Menu item, **(STIMULUS) MODE:** is set to **off**. To clear the warning message, on the Setup Menu set **(STIMULUS) MODE:** to **pulse**.
- **PROFILE PULSE IS OFF** – This warning message is displayed in red near the center of the Calibrate Menu display if the Setup Menu item, **(PROFILE) MODE:** is set to **off**. To clear the warning message, on the Setup Menu set **(PROFILE) MODE:** to **pulse** or **user**.
- **STIMULUS AND PROFILE PULSE ARE OFF** – This warning message is displayed in red near the center of the Calibrate Menu display if the Setup Menu items, **(STIMULUS) MODE:** and **(PROFILE) MODE:** are both set to **off**. To clear the warning message, on the Setup Menu set **(STIMULUS) MODE:** to **pulse** and **(PROFILE) MODE:** to **pulse** or **user**.

SECTION IV OPERATION VERIFICATION

CONTENTS

4-1	INTRODUCTION	4-3
4-2	REQUIRED EQUIPMENT	4-3
4-3	INITIAL SYSTEM SETUP	4-3
4-4	SAMPLER EFFICIENCY TEST	4-4
4-5	FREQUENCY TRACKING TESTS	4-5
4-5.1	Transmission Frequency Tracking Test	4-5
4-5.2	Reflection Frequency Tracking Test	4-6
4-6	EFFECTIVE DIRECTIVITY TEST	4-7
4-7	EFFECTIVE SOURCE MATCH TEST	4-8
4-8	SYSTEM DYNAMIC RANGE TEST	4-9
4-9	PULSED MODE TESTS	4-10
4-9.1	Fixed Pulse Profile Noise Test	4-10
4-9.2	Pulse Profile Noise Test	4-13

Table 4-1. Microwave Measurement Chart

Conversion tables for Return Loss, Reflection Coefficient, and SWR with tabular values for interaction of a small phasor x with a large phasor (unity reference) expressed in dB related to reference.

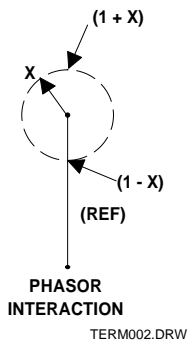

SWR	Reflection Coefficient	Return Loss (dB)	Relative to Unity Reference			
			X dB Below Reference	REF + X dB	REF - X dB	REF ± X Peak to Peak Ripple dB
17.3910	0.8913	1	1	5.5350	-19.2715	24.8065
8.7242	0.7943	2	2	5.0780	-13.7365	18.8145
5.8480	0.7079	3	3	4.6495	-10.6907	15.3402
4.4194	0.6310	4	4	4.2489	-8.6585	12.9073
3.5698	0.5623	5	5	3.8755	-7.1773	11.0528
3.0095	0.5012	6	6	3.5287	-6.0412	9.5699
2.6146	0.4467	7	7	3.2075	-5.1405	8.3480
2.3229	0.3981	8	8	2.9108	-4.4096	7.3204
2.0999	0.3548	9	9	2.6376	-3.8063	6.4439
1.9250	0.3162	10	10	2.3866	-3.3018	5.6884
1.7849	0.2818	11	11	2.1567	-2.8756	5.0322
1.6709	0.2512	12	12	1.9465	-2.5126	4.4590
1.5769	0.2239	13	13	1.7547	-2.2013	3.9561
1.4935	0.1995	14	14	1.5802	-1.9331	3.5133
1.4326	0.1778	15	15	1.4216	-1.7007	3.1224
1.3767	0.1585	16	16	1.2778	-1.4988	2.7766
1.3290	0.1413	17	17	1.1476	-1.3227	2.4703
1.2880	0.1259	18	18	1.0299	-1.1687	2.1986
1.2528	0.1122	19	19	0.9237	-1.0337	1.9574
1.2222	0.1000	20	20	0.8279	-0.9151	1.7430
1.1957	0.0891	21	21	0.7416	-0.8108	1.5524
1.1726	0.0794	22	22	0.6639	-0.7189	1.3828
1.1524	0.0708	23	23	0.5941	-0.6378	1.2319
1.1347	0.0631	24	24	0.5314	-0.5661	1.0975
1.1192	0.0562	25	25	0.4752	-0.5027	0.9779
1.1055	0.0501	26	26	0.4248	-0.4466	0.8714
1.0935	0.0447	27	27	0.3796	-0.3969	0.7765
1.0829	0.0398	28	28	0.3391	-0.3529	0.6919
1.0736	0.0355	29	29	0.3028	-0.3138	0.6166
1.0653	0.0316	30	30	0.2704	-0.2791	0.5495
1.0580	0.0282	31	31	0.2414	-0.2483	0.4897
1.0515	0.0251	32	32	0.2155	-0.2210	0.4365
1.0458	0.0224	33	33	0.1923	-0.1967	0.3890
1.0407	0.0200	34	34	0.1716	-0.1751	0.3467
1.0362	0.0178	35	35	0.1531	-0.1558	0.3090
1.0322	0.0158	36	36	0.1366	-0.1388	0.2753
1.0287	0.0141	37	37	0.1218	-0.1236	0.2454
1.0255	0.0126	38	38	0.1087	-0.1100	0.2187
1.0227	0.0112	39	39	0.0969	-0.0980	0.1949
1.0202	0.0100	40	40	0.0864	-0.0873	0.1737
1.0180	0.0089	41	41	0.0771	-0.0778	0.1548
1.0160	0.0079	42	42	0.0687	-0.0693	0.1380
1.0143	0.0071	43	43	0.0613	-0.0617	0.1230
1.0127	0.0063	44	44	0.0546	-0.0550	0.1096
1.0113	0.0056	45	45	0.0487	-0.0490	0.0977
1.0101	0.0050	46	46	0.0434	-0.0436	0.0871
1.0090	0.0045	47	47	0.0387	-0.0389	0.0776
1.0080	0.0040	48	48	0.0345	-0.0346	0.0692
1.0071	0.0035	49	49	0.0308	-0.0309	0.0616
1.0063	0.0032	50	50	0.0274	-0.0275	0.0549
1.0057	0.0028	51	51	0.0244	-0.0245	0.0490
1.0050	0.0025	52	52	0.0218	-0.0218	0.0436
1.0045	0.0022	53	53	0.0194	-0.0195	0.0389
1.0040	0.0020	54	54	0.0173	-0.0173	0.0347
1.0036	0.0018	55	55	0.0154	-0.0155	0.0309
1.0032	0.0016	56	56	0.0138	-0.0138	0.0275
1.0028	0.0014	57	57	0.0123	-0.0123	0.0245
1.0025	0.0013	58	58	0.0109	-0.0109	0.0219
1.0022	0.0011	59	59	0.0097	-0.0098	0.0195
1.0020	0.0010	60	60	0.0087	-0.0087	0.0174

SECTION IV OPERATION VERIFICATION

4-1 INTRODUCTION

This section contains eight operation verification tests that can be used to verify 360PS20A Pulsed/CW VNA system operation.

Setup instructions and performance procedures are included for each test. Test results can be compared with the specified limits that are provided for each test.

4-2 REQUIRED EQUIPMENT

The following equipment is required to perform the operation verification tests:

- WILTRON 3652 Calibration Kit with Option 1: Sliding Terminations.
- WILTRON 3670K50-2 Test Port Cable (Through Line).
- WILTRON 19K50 and 19KF50 Precision Air Lines.
- WILTRON 29K50-15 Precision Offsets.

4-3 INITIAL SYSTEM SETUP

Perform the following steps before starting the operation verification tests.

- a. Verify that the 360PS20A system has been installed per Section II - Installation.
- b. Install the 360 VNA system diskette (software version 3.07 required) into the disk drive of the network analyzer.
- c. Apply power to the frequency synthesizer then to the network analyzer. Loading of the system software takes approximately 1 minute (at which time the system is ready to make measurements). Allow the system to warm up for a period of 60 to 90 minutes to ensure operation to performance specifications.

NOTE

Do *not* apply power to the computer/controller at this time. During testing, you will be directed to apply power to it and to load the pulse application software when appropriate.

4-4 SAMPLER EFFICIENCY TEST

a. Test Description

This test verifies that each individual receiver channel in the Model 3636A Pulsed/CW Test Set operates to specifications. Calibration of the system is *not* required for this test.

b. Test Setup

1. Install a Through Line between Port 1 and Port 2 of the test set.
2. Set up the network analyzer as follows:

```

<SETUP MENU>      :   START: 890 MHz
                   :   STOP: 20 GHZ
<CHANNEL MENU>   :   ALL FOUR CHANNELS
<S-PARAMETER>    :   Channel 1: REF A*
                   :   Channel 2: TST A*
                   :   Channel 3: TST B*
                   :   Channel 4: REF B*
<GRAPH TYPE>     :   LOG MAGNITUDE (Channel 1 through Channel 4)
<AUTOSCALE>      :   ON (Channel 1 through Channel 4)
    
```

c. Test Procedure

1. Measure the amplitude slope on all four channels for a complete sweep (minimum to maximum frequency). Verify that the measured amplitude slope meets the following specification:

	REFERENCE CHANNELS	TEST CHANNELS
SLOPE	< 22 dB	< 27 dB

2. Measure the minimum amplitude level on all four channels for a complete sweep. Verify that the minimum measured amplitude meets the following specification:

	REF A	REF B	TST A	TST B
LEVEL (dBm)	-35	-43	-49	-33

* In order to independently measure the output of the individual test set channels of the test set, you need to redefine the selected parameter for each network analyzer display channel. This is accomplished using the S-PARAMETER MENU feature REDEFINE SELECTED PARAMETER. Using a denominator of 1 (UNITY), select the appropriate numerator to define the parameter for the test set channel to be displayed. The parameters are:

$$\frac{a_1}{1} = \text{Test Set Channel REF A}$$

$$\frac{b_1}{1} = \text{Test Set Channel TST A}$$

$$\frac{b_2}{1} = \text{Test Set Channel TST B}$$

$$\frac{a_2}{1} = \text{Test Set Channel REF B}$$

4-5 FREQUENCY TRACKING TESTS

The following tests verify that the 360PS20A system transmission frequency tracking and reflection frequency tracking meet specifications. The system *must* be calibrated and the error correction *applied* for these tests.

4-5.1 Transmission Frequency Tracking Test

a. Test Description

This test verifies that the transmission frequency tracking of the system meets specifications.

b. Test Setup

1. Perform a Full 12-Term sliding load calibration over the full system operating range. (Refer to the 360 VNA Operation Manual, Section 3 – Measurement Calibration for detailed procedures.) Apply the error correction.
2. Connect a Through Line between Port 1 and Port 2 of the test set.
3. Setup the network analyzer as follows:

```

<SETUP MENU>      :   START: 890 MHz
                   :   STOP: 20 GHz
<CHANNEL MENU>   :   DUAL DISPLAY CHANNEL 1-3
<S-PARAMETER>    :   CH1: S12
                   :   CH3: S21
<GRAPH TYPE>     :   LOG MAGNITUDE
<SCALE>          :   RESOLUTION: 0.030 dB/DIV
                   :   REF VALUE: 0 dB
<AVG/SMOOTH>     :   128 AVERAGES
<AVERAGE>       :   ON
<DATA POINTS>    :   NORMAL

```

c. Test Procedure

1. Allow the system to make one complete sweep. Store the trace data to memory and then view data ÷ memory for both channels, as follows:

```

CH1                :
TRACE MEMORY       :   STORE DATA TO MEMORY
                   :   then
                   :   VIEW DATA ÷ MEMORY
CH3                :
TRACE MEMORY       :   STORE DATA TO MEMORY
                   :   then
                   :   VIEW DATA ÷ MEMORY

```

2. Allow the system to make one complete sweep. Verify that the transmission frequency tracking falls within the specified limits:

```

CH1: S12           :   ±0.05 dB (0.890 to 2.0 GHz)
                   :   ±0.07 dB (2.0 to 20.0 GHz)
CH3: S21           :   ±0.05 dB (0.890 to 2.0 GHz)
                   :   ±0.07 dB (2.0 to 20.0 GHz)

```

4-5.2 Reflection Frequency Tracking Test

a. Test Description

This test verifies that the reflection frequency tracking of the system meets specifications.

b. Test Setup

1. Perform a Full 12-Term sliding load calibration over the full system operating range. If you have just completed the transmission frequency tracking test, you may use the same calibration. Apply the error correction.
2. Connect a Short to Port 1 and a Through Line terminated with a Short to Port 2 of the test set.
3. Setup the network analyzer as follows:

```

<SETUP MENU>      :   START: 890 MHz
                   :   STOP: 20 GHz
<CHANNEL MENU>   :   DUAL DISPLAY CHANNEL 1-3
<S-PARAMETER>    :   CH1: S11
                   :   CH3: S22
<GRAPH TYPE>     :   LOG MAGNITUDE
<SCALE>          :   RESOLUTION: 0.010 dB/DIV
                   :   REF VALUE: 0 dB
<AVG/SMOOTH>     :   128 AVERAGES
<AVERAGE>       :   ON
<DATA POINTS>    :   MAXIMUM
<IF BANDWIDTH>   :   REDUCED
    
```

c. Test Procedure

1. Allow the system to make one complete sweep. Store the trace data to memory and then view data ÷ memory for both channels, as follows:

```

CH1                :
TRACE MEMORY       :   STORE DATA TO MEMORY
                   :   then
                   :   VIEW DATA ÷ MEMORY
CH3                :
TRACE MEMORY       :   STORE DATA TO MEMORY
                   :   then
                   :   VIEW DATA ÷ MEMORY
    
```

2. Allow the system to make one complete sweep. Verify that the reflection frequency tracking falls within the specified limits:

```

CH1: S11           :   ±0.02 dB (0.890 to 2.0 GHz)
                   :   ±0.03 dB (2.0 to 20.0 GHz)
CH3: S22           :   ±0.02 dB (0.890 to 2.0 GHz)
                   :   ±0.03 dB (2.0 to 20.0 GHz)
    
```

4-6 EFFECTIVE DIRECTIVITY TEST**a. Test Description**

This test verifies that the effective directivity of the system meets specifications. The system *must* be calibrated and the error correction *applied* for these tests.

b. Test Setup

1. Perform a Full 12-Term sliding load calibration over the full system operating range. If you have just completed the frequency tracking tests, you may use the same calibration. Apply the error correction.

2. Set up the network analyzer as follows:

```

<SETUP MENU>      :   START: 890 MHz
                   :   STOP: 20 GHz
<CHANNEL MENU>   :   SINGLE CHANNEL
<S-PARAMETER>    :   S11
<GRAPH TYPE>     :   LOG MAGNITUDE
<SCALE>          :   RESOLUTION: 1.0 dB/DIV
                   :   REF VALUE: offset value

```

c. Test Procedure

1. Connect an Air Line and an Offset to Port 1 of the test set.

2. Allow the system to make one complete sweep. Using the Microwave Measurement Chart (Table 4-1, page 4-2), verify that the system (S11 Port 1) effective directivity meets specifications.

```

0.890 to 2.0 GHz   ≥ 42 dB
2.0 to 20.0 GHz   ≥ 42 dB

```

3. Change the network analyzer setup as follows:

```

<S-PARAMETER>    :   S22
<GRAPH TYPE>     :   LOG MAGNITUDE
<SCALE>          :   RESOLUTION: 1.0 dB/DIV
                   :   REF VALUE: offset value

```

4. Connect an Air Line and an Offset to Port 2 of the test set.

5. Allow the system to make one complete sweep. Using the Microwave Measurement Chart, verify that the system (S22 Port 2) effective directivity meets specifications.

```

0.890 to 2.0 GHz   ≥ 42 dB
2.0 to 20.0 GHz   ≥ 42 dB

```

4-7 EFFECTIVE SOURCE MATCH TEST**a. Test Description**

This test verifies that the effective source match of the system meets specifications. The system *must* be calibrated and the error correction *applied* for these tests.

b. Test Setup

1. Perform a Full 12-Term sliding load calibration over the full system operating range. If you have just completed the frequency tracking tests, you may use the same calibration. Apply the error correction.
2. Set up the network analyzer as follows:

```

<SETUP MENU>      :   START: 890 MHz
                   :   STOP: 20 GHz
<CHANNEL MENU>   :   SINGLE CHANNEL
<S-PARAMETER>    :   S22
<GRAPH TYPE>     :   LOG MAGNITUDE
<SCALE>          :   RESOLUTION: 0.2 dB/DIV
                   :   REF VALUE: 0 dBm
  
```

c. Test Procedure

1. Connect an Air Line and a Short to Port 2 of the test set.
2. Allow the system to make one complete sweep. Using the Microwave Measurement Chart (Table 4-1, page 4-2), verify that the system (S22 Port 2) effective source match meets specifications.

```

0.890 to 2.0 GHz      ≥ 40 dB
2.0 to 20.0 GHz      ≥ 38 dB
  
```

3. Change the network analyzer setup as follows:

```

<S-PARAMETER>      :   S11
<GRAPH TYPE>       :   LOG MAGNITUDE
<SCALE>            :   RESOLUTION: 0.2 dB/DIV
                   :   REF VALUE: 0 dBm
  
```

4. Connect an Air Line and a Short to Port 1 of the test set.
5. Allow the system to make one complete sweep. Using the Microwave Measurement Chart, verify that the system (S11 Port 1) effective source match meets specifications.

```

0.890 to 2.0 GHz      ≥ 40 dB
2.0 to 20.0 GHz      ≥ 38 dB
  
```

4-8 SYSTEM DYNAMIC RANGE TEST**a. Test Description**

This test verifies that the system dynamic range meets specifications. System dynamic range is defined as the ratio of power incident on Port 2 in a through line connection to the noise floor at Port 2 (forward measurements only). The system *must* be calibrated and the error correction *applied* for this test.

b. Test Setup

1. Perform a Full 12-Term sliding load calibration over the full system operating range. Minimum IF Bandwidth and 1024 Averages *must* be used during the isolation step of the calibration procedure. (Refer to the 360 VNA Operation Manual, Section 3 – Measurement Calibration for detailed procedures.) Apply the error correction.
2. Connect Broadband Terminations to Port 1 and Port 2 of the test set.
3. Set up the network analyzer as follows:

```

<CHANNEL MENU>      :   SINGLE CHANNEL
<S-PARAMETER>      :   S21
<GRAPH TYPE>       :   LOG MAGNITUDE
<SCALE>            :   RESOLUTION: 10.0 dB/DIV
                   :   REF VALUE: -50.0 dB
                   :   REF LINE: TOP
<AVG/SMOOTH>       :   1024 AVERAGES
<AVERAGE>         :   ON
<IF BANDWIDTH>     :   MINIMUM
<OPTIONS>          :   SWEEP OPTIONS
                   :   then
                   :   POINTS DRAWN IN C.W.: 100
<LIMITS>           :   LIMIT 1: 100 dBc (for 890 MHz)
                   :   103 dBc (for 2.0 GHz)
                   :   83 dBc (for 20.0 GHz)

```

c. Test Procedure

1. On the network analyzer, press the **SETUP MENU** key to display the SWEEP SETUP menu. Select C.W.MODE ON and enter 890 MHz. Allow the system to make one forward sweep, then place it in HOLD.

890 MHz : > 100 dBc
2. Ensure that the difference between the maximum and minimum point is > 20 dB. Subtract 6 dB from the maximum point. This is the System Dynamic Range. Verify the noise floor meets specifications.
3. On the network analyzer, change the C.W.MODE ON frequency to 2.0 GHz. Allow the system to make one forward sweep, then place it in HOLD.
4. Ensure that the difference between the maximum and minimum point is > 20 dB. Subtract 6 dB from the maximum point. This is the System Dynamic Range. Verify the noise floor meets specifications.

2.0 GHz : > 103 dBc
5. On the network analyzer, change the C.W.MODE ON frequency to 20.0 GHz. Allow the system to make one forward sweep, then place it in HOLD.
6. Ensure that the difference between the maximum and minimum point is > 20 dB. Subtract 6 dB from the maximum point. This is the System Dynamic Range. Verify the noise floor meets specifications.

20.0 GHz : > 83 dBc

4-9 PULSED MODE TESTS

The following tests verify that the 360PS20A system meets transmission and reflection noise specifications when operating in the pulsed measurement mode (fixed pulse profile and pulse profile).

a. Initial Setup

Perform the following steps before starting the pulsed mode tests.

1. Power up the 360CC computer/controller. The computer first performs a self-test of its memory, then boots. Once the computer/controller is fully booted, the start up display (Figure 3-10, page 3-15) appears on the monitor.
2. Following the procedure on page 3-15, load the pulse application software program. When the pulse application software program is loaded and ready to run, the program title screen (Figure 3-11, page 3-18) is displayed on the monitor.

4-9.1 Fixed Pulse Profile Noise Test

a. Test Description

This test verifies that the fixed pulse profile transmission and reflection noise of the system (at minimum pulse width and maximum PRF) meets specifications.

b. Test Setup

1. Install a Through Line between Port 1 and Port 2 of the test set.
2. On the computer/controller, press <ENTER> on the keyboard to begin. The Main Menu is displayed. On the Main Menu, select SETUP or press function key F3 to access the Setup Menu. The computer/controller places the network analyzer in receiver set on mode and sets up for a pulse profile measurement.
3. Set up the computer/controller Setup Menu as follows (*in this order*):

```

MEAS MODE       : fixed profile
PRF              : 950.000 KHz
(STIMULUS) WIDTH : 0.050000 μsec
(STIMULUS) DELAY : 0.000000 μsec
(STIMULUS) MODE  : pulse
(PROFILE) WIDTH  : 0.020000 μsec
(PROFILE) DELAY  : 0.015000 μsec
(PROFILE) MODE   : pulse
  
```

4. Set up the network analyzer as follows:

```

<SETUP MENU>    : C.W. MODE ON: 0.890 GHz
<OPTIONS>       : SWEEP OPTIONS
                  then
                  POINTS DRAWN IN C.W.: 100
<CHANNEL MENU> : DUAL DISPLAY CHANNEL 1-3
<S-PARAMETER>  : CH1: S12
<GRAPH TYPE>   : LOG MAGNITUDE
<SCALE>        : RESOLUTION: 0.10 dB/DIV
                  REFERENCE LINE: CENTER
  
```

```

<S-PARAMETER>      :   CH3: S21
<GRAPH TYPE>       :   LOG MAGNITUDE
<SCALE>            :   RESOLUTION: 0.05 dB/DIV
                   :   REFERENCE LINE: CENTER
<AVG/SMOOTH>      :   1024 AVERAGES
<AVERAGE>         :   ON

```

c. Test Procedure

1. Transmission Noise

- (a) Allow the system to make one complete sweep. Store the trace data to memory and then view data ÷ memory for both channels, as follows:

```

CH1                :
TRACE MEMORY       :   STORE DATA TO MEMORY
                   :   then
                   :   VIEW DATA ÷ MEMORY

CH3                :
TRACE MEMORY       :   STORE DATA TO MEMORY
                   :   then
                   :   VIEW DATA ÷ MEMORY

```

- (b) Allow the system to make one complete sweep. Verify that the transmission noise at 890 MHz falls within the specified limits:

```

CH1: S12           :   < ±0.20 dB noise
CH3: S21           :   < ±0.10 dB noise

```

- (c) On the network analyzer, change the **<SETUP MENU>**: CW FREQ: to 20.0 GHz.

- (d) Allow the system to make one complete sweep. Store the trace data to memory and then view data ÷ memory for both channels, as follows:

```

CH1                :
TRACE MEMORY       :   STORE DATA TO MEMORY
                   :   then
                   :   VIEW DATA ÷ MEMORY

CH3                :
TRACE MEMORY       :   STORE DATA TO MEMORY
                   :   then
                   :   VIEW DATA ÷ MEMORY

```

- (e) Allow the system to make one complete sweep. Verify that the transmission noise at 20.0 GHz falls within the specified limits:

```

CH1: S12           :   < ±0.50 dB noise
CH3: S21           :   < ±0.30 dB noise

```

2. Reflection Noise

- (a) Connect a Short to Port 1 and an Open to Port 2 of the test set.
- (b) On the network analyzer, change **<S-PARAMETER>**: CH1: to S22 and CH3: to S11.
- (c) Allow the system to make one complete sweep. Store the trace data to memory and then view data ÷ memory for both channels, as follows:

```

CH1          :
TRACE MEMORY :   STORE DATA TO MEMORY
              :   then
              :   VIEW DATA ÷ MEMORY

CH3          :
TRACE MEMORY :   STORE DATA TO MEMORY
              :   then
              :   VIEW DATA ÷ MEMORY

```

- (d) Allow the system to make one complete sweep. Verify that the reflection noise at 20.0 GHz falls within the specified limits:

```

CH1: S22      :   < ±0.50 dB noise
CH3: S11      :   < ±0.30 dB noise

```

- (e) On the network analyzer, change the **<SETUP MENU>**: CW FREQ: to 890 MHz.
- (f) Allow the system to make one complete sweep. Store the trace data to memory and then view data ÷ memory for both channels, as follows:

```

CH1          :
TRACE MEMORY :   STORE DATA TO MEMORY
              :   then
              :   VIEW DATA ÷ MEMORY

CH3          :
TRACE MEMORY :   STORE DATA TO MEMORY
              :   then
              :   VIEW DATA ÷ MEMORY

```

- (g) Allow the system to make one complete sweep. Verify that the reflection noise at 890 MHz falls within the specified limits:

```

CH1: S22      :   < ±0.20 dB noise
CH3: S11      :   < ±0.10 dB noise

```

4-9.2 Pulse Profile Noise Test

a. Test Description

This test verifies that the pulse profile transmission and reflection noise of the system (at minimum PRF) meets specifications.

b. Test Setup

1. From the computer/controller Main Menu, select SETUP or press F3 to access the Setup Menu. Set up the computer/controller Setup Menu as follows (*in this order*):

MEAS MODE	:	pulse profile
PRF	:	1.000 KHz
(STIMULUS) WIDTH	:	100.000000 μ sec
(STIMULUS) DELAY	:	10.000000 μ sec
(STIMULUS) MODE	:	pulse
(PROFILE) WIDTH	:	5.000000 μ sec
(PROFILE) DELAY	:	50.000000 μ sec
(PROFILE) MODE	:	pulse
(PULSE PROFILE)		
START	:	0.000000 μ sec
STOP	:	120.000000 μ sec
STEP	:	1.500000 μ sec
CW FREQ	:	0.890000 GHz
AVG	:	on
NUM AVG	:	128

2. Install a Through Line between Port 1 and Port 2 of the test set.
3. On the computer/controller, press function key F4. The Calibrate Menu is displayed and the VNA is placed in local mode so that you can manually calibrate it. Perform a 2-point (890 MHz and 20 GHz) 12-Term Broadband Load calibration. When complete, apply the error correction, then press computer/controller function key F5. This returns the VNA to remote control and initiates a pulse profile measurement.

c. Test Procedure

1. Transmission Noise

- (a) At the completion of the pulse profile measurement, S21 data is displayed on the computer/controller monitor. Press function key F7 to display the Scale Menu, then set the -LOG MAG- RESOLUTION to 0.400 dB/DIV and the -PHASE- RESOLUTION to 4.00°/DIV.

- (b) Verify that the transmission noise inside the pulse profile window falls within the specified limits:

S21	:	< ± 0.4 dB / $\pm 4.00^\circ$ noise (with up to 0.4 dB / 4.00° offset)
-----	---	---

- (c) Press function key F6 to display the Display Menu, then select menu item S-PARAMETER. On the S-Parameter Menu, select S12 REV TRANS for display. Press function key F7 to display the Scale Menu, then set the -LOG MAG- RESOLUTION to 1.0 dB/DIV and the -PHASE- RESOLUTION to 10.00°/DIV.

- (d) Verify that the transmission noise inside the pulse profile window falls within the specified limits:

S12	:	< ± 1.0 dB / $\pm 10.00^\circ$ noise (with up to 1.0 dB / 10.00° offset)
-----	---	---

- (e) Press function key F3 to display the Setup Menu. On the Setup Menu, change CW FREQ: to 20.000000 GHz. Press Function F5 to initiate a pulse profile measurement. Press function key F7

to display the Scale Menu, then set the -LOG MAG- RESOLUTION to 2.0 dB/DIV and the -PHASE- RESOLUTION to 10.00°/DIV.

- (f) Verify that the transmission noise inside the pulse profile window falls within the specified limits:

S21 : < ± 2.0 dB / $\pm 10.00^\circ$ noise
(with 2.0 dB / 10.00° offset)

- (g) Press function key F6 to display the Display Menu, then select menu item S-PARAMETER. On the S-Parameter Menu, select S12 REV TRANS for display. Press function key F7 to display the Scale Menu, then set the -LOG MAG- RESOLUTION to 10.0 dB/DIV and the -PHASE- RESOLUTION to 40.00°/DIV.

- (h) Verify that the transmission noise inside the pulse profile window falls within specified limits:

S12 : < ± 10.0 dB / $\pm 40.00^\circ$ noise
(with 10.0 dB / 40.00° offset)

2. Reflection Noise

- (a) Disconnect the Through Line and connect a Short to Port 1 and a Short to Port 2 of the test set.

- (b) Press function key F5 to initiate a pulse profile measurement.

- (c) At the completion of the pulse profile measurement, S21 data is displayed on the the computer/controller monitor. To change the display to S11 data, select S-PARAMETER from the Display Menu. On the S-Parameter Menu, select S11 FWD REFL.

- (d) Press F6 to return to the Display Menu, then select GRAPH TYPE from the menu. At the Graph Type Menu, select LOG MAGNITUDE. Press function key F7 to display the Scale Menu, then set the -LOG MAG- RESOLUTION to 2.0 dB/DIV.

- (e) Verify that the reflection noise inside the pulse profile window falls within the specified limits:

S11 : < ± 2.0 dB noise (2.0 dB offset)

- (f) Press function key F6 to display the Display Menu, then select menu item S-PARAMETER. On the S-Parameter Menu, select S22 REV REFL for display. Press function key F7 to display the Scale Menu, then set the -LOG MAG- RESOLUTION to 10.0 dB/DIV

- (g) Verify that the reflection noise inside the pulse profile window falls within the specified limits:

S22 : < ± 10.0 dB noise (10.0 dB offset)

- (h) Press function key F3 to return to the Setup Menu. On the Setup Menu, change **CW FREQ:** to 0.890000 GHz. Press function key F5 to initiate a pulse profile measurement.

- (i) At the completion of the pulse profile measurement, S21 data is displayed on the the computer/controller monitor. To change the display to S11 data, select S-PARAMETER from the Display Menu. On the S-Parameter Menu, select S11 FWD REFL. Press function key F7 to display the Scale Menu, then set the -LOG MAG- RESOLUTION to 0.4 dB/DIV

- (j) Verify that the reflection noise inside the pulse profile window falls within the specified limits:

S11 : < ± 0.4 dB noise (0.4 dB offset)

- (k) Press function key F6 to display the Display Menu, then select menu item S-PARAMETER. On the S-Parameter Menu, select S22 REV REFL for display. Press function key F7 to display the Scale Menu, then set the -LOG MAG- RESOLUTION to 2.0 dB/DIV

- (l) Verify that the reflection noise inside the pulse profile window falls within the specified limits:

S22 : < ± 2.0 dB noise (2.0 dB offset)

360 AUXILIARY CONTROL MODULE MAINTENANCE MANUAL

This manual is a supplement for the following manuals:

3635B mm-Wave Test Set Maintenance Manual
3636A Pulsed/CW Test Set Maintenance Manual
3642A Noise Figure Module Maintenance Manual
360NF20A Noise Figure Analyzer Operation Manual
360PS20A Pulsed/CW Vector Network Analyzer
Operation Manual

Insert this manual behind the tab marked "Supplements"
in your 3635B, 3636A, 3642A, 360NF20A, or 360PS20A
manual, as appropriate.

WARRANTY

The WILTRON product(s) listed on the title page is (are) warranted against defects in materials and workmanship for one year from the date of shipment.

WILTRON's obligation covers repairing or replacing products which prove to be defective during the warranty period. Buyers shall prepay transportation charges for equipment returned to WILTRON for warranty repairs. Obligation is limited to the original purchaser. WILTRON is not liable for consequential damages.

LIMITATION OF WARRANTY

The foregoing warranty does not apply to WILTRON connectors that have failed due to normal wear. Also, the warranty does not apply to defects resulting from improper or inadequate maintenance by the Buyer, unauthorized modification or misuse, or operation outside of the environmental specifications of the product. No other warranty is expressed or implied, and the remedies provided herein are the Buyer's sole and exclusive remedies.

360 AUXILIARY CONTROL MODULE MAINTENANCE MANUAL

Contents

Paragraph	Description	Page
1.	INTRODUCTION	1
2.	INSTALLATION	1
3.	ACM MAINTENANCE	2
3.1	Functional Overview Of The 360ACM	2
3.2	Preventive Maintenance	2
3.3	Troubleshooting Procedures	2
4.	ACM REPLACEABLE PARTS	4
5.	ACM SERVICE DRAWINGS	4
6.	ACM SPECIFICATIONS	4

1. INTRODUCTION

The WILTRON 360 Auxiliary Control Module (360ACM or, ACM) is a system auxiliary unit that performs the functions listed below when installed into 360 Vector Network Analyzer systems.

- Supplies +5V (or -5V), +6V, +8V and +15V (or -15V) power supply voltages to test sets and Noise Figure Modules that require these additional power sources.
- Provides mounting space and primary power control for a 360PSG pulse generator. (This optional unit is installed into the 360ACM for 360PS20A Pulsed/CW Vector Network Analyzer Systems.)
- Provides mounting space and primary power control for a 360YTC YIG tracking filter controller. (This optional unit is installed into the 360ACM for 360NF20A Noise Figure Systems.)

2. INSTALLATION

To install the 360ACM into the system, proceed as follows:

1. Before installing the 360ACM into the system, verify that the 360ACM Line Module Assembly (rear panel) is set for the correct line voltage (Figure 3).

CAUTION

Failure to set the 360ACM Line Module Assembly correctly for the line voltage used may result in damage to the 360ACM and any 360PSG pulse generator and/or 360YTC YIG tracking filter controller installed in the 360ACM.

2. Verify that any 360PSG pulse generator and/or 360YTC YIG tracking filter controller installed into the 360ACM is set for 110–120 Vac line voltage operation.

NOTE

When operating with 220–240 Vac line voltage input, the 360ACM converts the line voltage for the 360PSG and/or 360YTC to 110–120 Vac.

3. Prepare the system console to position the 360ACM in the desired location. The preferred location is at the bottom of the system console.
4. Fasten the 360ACM into the location prepared in step 2 above with the mounting hardware provided.

5. Connect the auxiliary dc power cable from the rear panel of the ACM to the rear panel POWER DIST SUPPLY connector of the 3635B (or 3636A) test set. If installing the ACM into a 360NF20A Noise Figure System, connect the BNO cable from the ACM rear panel +5V/ RELAY connector to the +5V/ RELAY connector of the 3642A Noise Figure Module.
6. Connect the power cable to the ACM Line Module Assembly and to the system console power strip.

NOTE

Instructions for installing the pulse generator module into the 360ACM are included in the manuals supplied with the 360PS20A Pulsed/CW Vector Network Analyzer System. Instructions for installing the YIG tracking filter controller module are included in the manuals supplied with the 360NF20A Noise Figure System.

3. ACM MAINTENANCE

3.1 Functional Overview Of The 360ACM

Refer to Figure 1, Figure 2 (page 5), and to Figure 4 (page 7); these figures show the location and the interconnection of the major assemblies that comprise the 360ACM. The major assemblies are:

- 12V Power Supply Assembly,
- 15V Power Supply Assembly,
- A100 Auxiliary Control Module PCB Assembly,
- Line Module Assembly,
- Power Transformer,
- Duplex Outlet Assembly,
- Rear Panel Connector/Cable Assemblies.

The A100 Auxiliary Control Module PCB Assembly contains power-on logic relays (K1 and K2), voltage regulators (VR1 – VR4), a 12V time delay circuit (Q1, Q2), and fuses for the power supply assemblies (F1 – F4). This assembly routes primary power from the Line Module Assembly to the 12V and 15V power supply assemblies via relay K1 and fuses F1 – F4.

Transistors Q1 and Q2 comprise a time delay circuit that delays the output of the 12V power supply assembly approximately one-half second at turn-on. The output of Q1 is applied to the inputs of voltage regulators VR1 and VR2.

Voltage regulators VR1 and VR2 output 6V and 8V, respectively. Voltage Regulator VR4 converts the output of the 15V power supply assembly to 5V. All of these voltages are routed via connector J8 to the rear panel 15 pin “D” connector, which is the main interface to the 360 VNA test set.

Voltage Regulator VR3 converts the output of the 12V power supply assembly to 5V; this second 5V power source is used to light the front panel POWER indicator LED. It is also routed to the rear panel BNO connector (via connector J7) and is the RP BNC SIG voltage fed to the 3642A Noise Figure Module (used only with 360NF20A Noise Figure Systems). This voltage is used by the 3642A for amplifier biasing.

3.2 Preventive Maintenance

There are no 360ACM components that require preventive maintenance.

3.3 Troubleshooting Procedures

The level of troubleshooting and repair that may be performed for the 360ACM in the field consists of replacement of defective power supply modules and replacement of voltage regulators and fuses located on the A100 auxiliary control module PCB assembly. All major 360ACM assemblies (including the entire A100 Auxiliary Control Module PCB assembly) may also be replaced, as required.

To troubleshoot, proceed as follows:

1. Remove power from the system.
2. Unfasten screws securing 360ACM front panel to system console and slide unit out of system console.
3. Remove the screws securing the top cover and remove cover.
4. Remove the four screws securing the A100 auxiliary control module PCB protective cover and remove cover.

WARNING

Voltages hazardous to life are exposed when operating the 360ACM with the A100 auxiliary control module PCB protective cover removed. Use extreme caution when operating in this manner.

5. Apply power to the system in normal manner (with rear panel cables from test set/noise figure module in place). Measure the voltages listed in Table 1 (page 4). Note that the voltage at TP6 is the output voltage of the 15V power supply assembly and that TP8 is the output voltage of the 12V power supply assembly (after time-delay circuit).
6. If there are no dc voltages present at the test points, *carefully* determine if line voltage is present between fuses F1 and F2 and between

F3 and F4 of the A100 PCB. If line voltage is not present, disconnect power cord and check the Line Module Assembly fuse (Figure 3).

WARNING

Line voltages hazardous to life are normally present on these fuses. Voltages up to 240 Vac may be present.

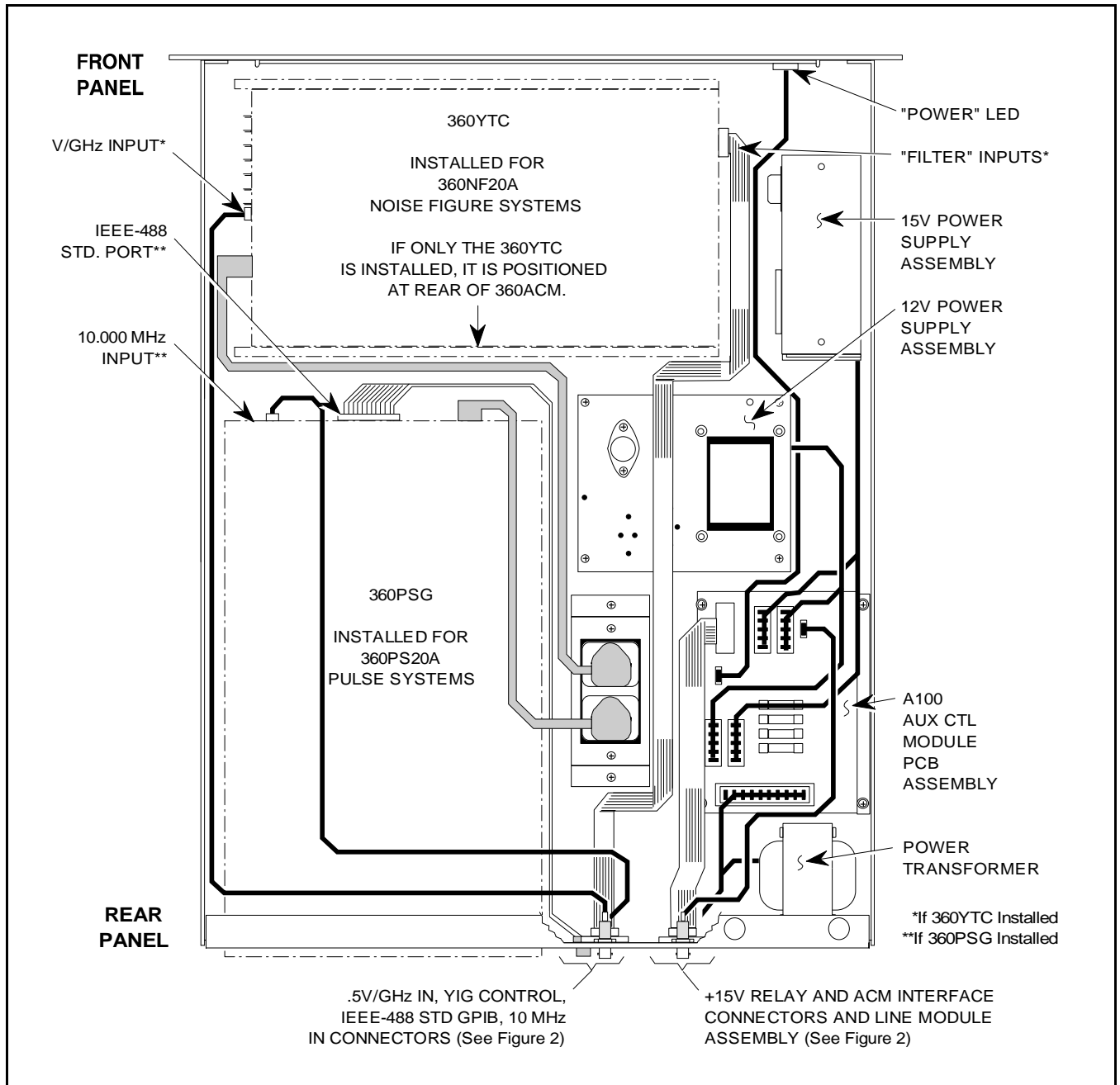

Figure 1. 360ACM Major Parts Location Diagram

7. If Line Module Assembly fuse is OK, re-apply line voltage to the ACM and carefully measure the dc voltage across the coil of relay K1 (measure across CR1). This voltage is supplied by the test set and should measure $5V \pm 0.3Vdc$. If voltage is OK, K1 is defective.
8. If line voltage is present, check that fuses F1 – F4 are not open (i.e., no voltage drop across each fuse). If the fuses are OK and there is no dc output (or incorrect output) from either power supply assembly, replace the suspected assembly.
9. If there are dc voltages present at the test points, but they are the wrong value, determine which voltage regulator or power supply module output(s) are at fault. Before replacing a suspected voltage regulator, determine that excessive current is not being drawn by the test set (i.e, overheating cables, shorted cables, overheating test set components, etc).
10. If the +5V is OK at TP4, but the front panel POWER LED is not lit, check for defective cable connection at A100(J9), or defective cable, or defective LED.

4. ACM REPLACEABLE PARTS

The major replaceable assemblies of the 360ACM are listed in Table 2. The replaceable parts of the

Table 1. 360 ACM Test Point Voltages

Test Point	Measured Voltage*	Reference Test Point
TP2	$6.0 \pm 0.2 Vdc$	TP1
TP3	$8.0 \pm 0.2 Vdc$	TP1
TP4	$5.0 \pm 0.2 Vdc$	TP1
TP5	$5.0 \pm 0.2 Vdc$	TP7
TP6	$15.0 \pm 0.3 Vdc$	TP7
TP8	$11.5 \pm 0.3 Vdc$	TP1

* All voltages shown must be measured with a voltmeter having floating (i.e., ungrounded) inputs.

A100 auxiliary control module PCB are listed in Table 3.

5. ACM SERVICE DRAWINGS

The parts locator diagram and the schematic for the A100 auxiliary control module PCB are contained in Figures 5 and 6. The pin-outs of the rear panel connectors of the 360ACM are shown in Figure 7.

6. ACM SPECIFICATIONS

Power Requirements

- W/O 360PSG or 360YTC:
100/120/220/240V, 60/50 Hz, 190 VA max
- With 360PSG or 360YTC:
100/120/220/240V, 60/50 Hz, 540 VA max

Dimensions:

- 133H x 432W x 603D mm
(5.25H x 17W x 23.75D in.)

Weight (W/O 360PSG or 360YTC):

- Approx 10.9 kg (24 lb.)

Table 2. 360 ACM Major Replaceable Assemblies

Assembly Name	WILTRON Part No.	Module Exchange Part No.	Field Replaceable Parts
15V Power Supply Assembly	B37862	B37862	No
12V Power Supply Assembly	B37863	B37863	No
Auxiliary Control Module PCB Assembly (A100)	D37719-3	D37719-3	Yes (see Table 3)
Line Module	260-24	—	No
Duplex Outlet	260-22	—	No
Power Transformer	320-144	—	No
Powercord, 3 Cond. 18AWG	800-119	—	No

NOTE: Refer to the manuals provided with the 360PSG Pulse Generator and/or 360YTC YIG Tracking Filter Controller for replaceable parts information for those units.

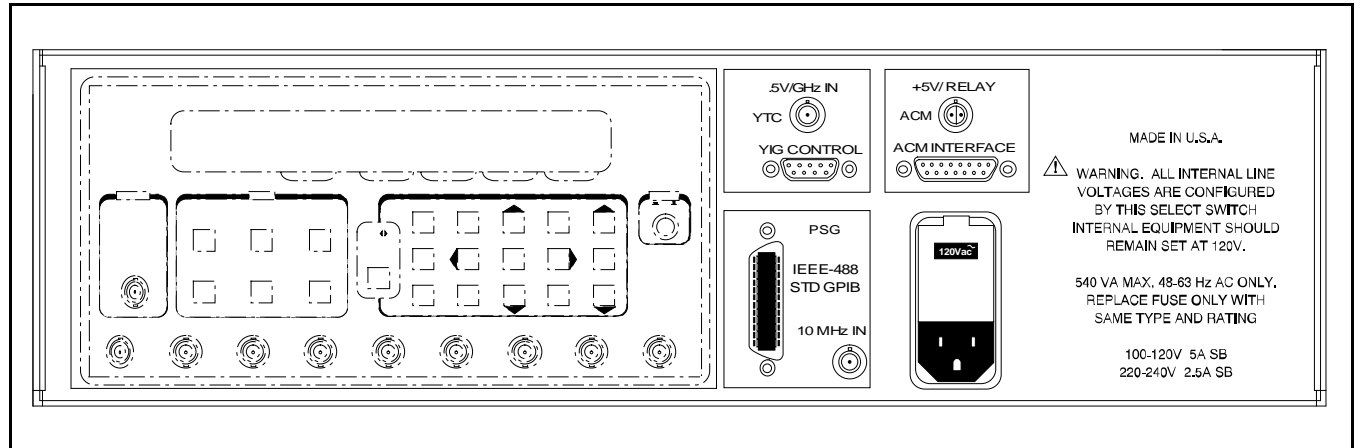
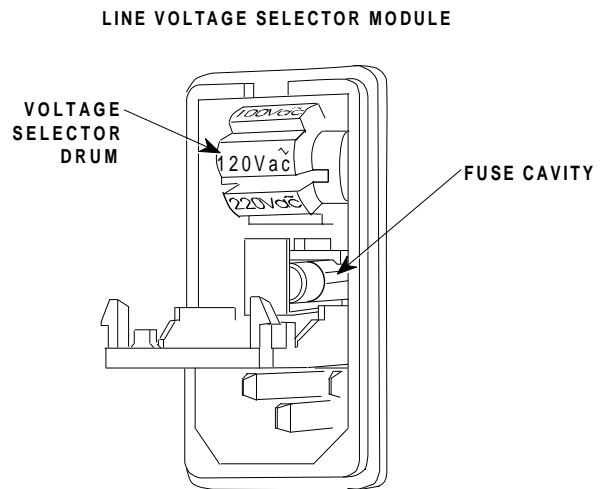

Figure 2. 360ACM Rear Panel Layout Diagram

To change the line voltage from that shown on the Line Voltage Module selector drum, proceed as follows:

- (a) Remove the power cord from the line voltage module.
- (b) Insert the blade of a small screwdriver into the slot at the top-center of the module, and pry open the cover.
- (c) Remove the voltage selector drum by pulling straight out.
- (d) Rotate the drum so that the desired line voltage marking faces out, then reinstall the drum.
- (e) Remove the fuse cartridge from the right-hand fuse-holder. The fuse cartridge is identified with a white arrow and is located beneath the voltage selector drum.
- (f) Check that the proper fuse is installed (see table).
- (g) Change to the correct fuse, if necessary, and replace the fuse cartridge.
- (h) Close the cover, and ensure that the desired line voltage value is displayed through the opening in the cover.
- (i) Reinstall the line cord.



Line Voltage Settings and Fuse Sizes

Line Voltage Setting	Area	Fuse Rating	Fuse Size	Wiltron P/N Fuse
100 Vac	USA/Japan	5.0A, Antisurge	3AG	631-33
120 Vac	USA/Japan	5.0A, Antisurge	3AG	631-33
220 Vac	UK/Europe	2.5A, Antisurge	3AG	631-14
240 Vac	UK/Europe	2.5A, Antisurge	3AG	631-14

Figure 3. Setting the Line Voltage Module Operating Voltage

Table 3. A100 Auxiliary Control Module PCB Assembly Parts List

REF DES	WPN	DESCRIPTION	VENDOR PART NUMBER	VENDOR NAME
C1	250-42	CAPACITOR,FXD,TANT,10 μ F,10%	T350G106K35AS	KEMET
C2	250-42	CAPACITOR,FXD,TANT,10 μ F,10%	T350G106K35AS	KEMET
C3	250-42	CAPACITOR,FXD,TANT,10 μ F,10%	T350G106K35AS	KEMET
C4	250-42	CAPACITOR,FXD,TANT,10 μ F,10%	T350G106K35AS	KEMET
C5	250-42	CAPACITOR,FXD,TANT,10 μ F,10%	T350G106K35AS	KEMET
C6	250-42	CAPACITOR,FXD,TANT,10 μ F,10%	T350G106K35AS	KEMET
C7	230-37	CAPACITOR,FXD,CER,0.1 μ F,20%,10V	RPE122901Z5U104M100V	MURATA/VERIE
C8	250-19	CAPACITOR,FXD,TANT,1 μ F,10%,35V	199D105X9035HE3	SPRAGUE
CR1	10-SI2	DIODE,RECTIFIER,IN4003,200V	SS6253	SEMTECH
CR2	10-1N4446	DIODE,SWITCHING,1N4446,75V,4ns	1N4446	NATIONAL SEMI
F1	631-11	FUSE,1A,3AG,SLOW BLOW	313001	LITTLEFUSE
F2	631-11	FUSE,1A,3AG,SLOW BLOW	313001	LITTLEFUSE
F3	631-3	FUSE,0.5A,3AG,SLOW BLOW	313.500	LITTLE FUSE
F4	631-3	FUSE,0.5A,3AG,SLOW BLOW	313.500	LITTLE FUSE
J1	551-234	CONNECTOR,HDR,PC MNT,10 SNGL	09-60-1101	MOLEX
J3	551-99	CONNECTOR,HDR,PCB MNT,6 PIN SN	09-60-1061	MOLEX
J4	551-99	CONNECTOR,HDR,PCB MNT,6 PIN SN	09-60-1061	MOLEX
J5	551-32	CONNECTOR,HDR,PCB MNT,5 POS	09-60-1051	MOLEX
J6	551-32	CONNECTOR,HDR,PCB MNT,5 POS	09-60-1051	MOLEX
J7	551-707	CONN,HEADER,1 ROW - .100",PC	69167-103	BERG-DU PONT
J8	551-512	CONN,R&P,PLUG,15,PC MNT	FDA15P-964	SOURIAU
J9	551-707	CONN,HEADER,1 ROW - .100",PC	69167-103	BERG-DU PONT
K1	690-73	RELAY,2C,5V,47*,5A,240VAC	RKA-11DZ-05	POTTER BRUMFIELD
K2	690-64	RELAY,DPDT,2C,5VDC,80mW	TF2E-5V	AROMAT
Q1	20-2N6041	TRANSISTOR,PNP,2N6041,Si	2N6041	MOTOROLA
Q2	20-57	TRANSISTOR,FET,VN10K,VMOS	VN10KM	SILICONIX
R1	110-121-1	RESISTOR,FXD,MF, 121 Ω ,1%,0.25W	RN 1/4-T1-121E-1%	STACKPOLE
R2	110-464-1	RESISTOR,FXD,MF, 464 Ω ,1%,0.25W	RN 1/4-T1-464E-1%	STACKPOLE
R3	110-121-1	RESISTOR,FXD,MF,121 Ω ,1%,0.25W	RN 1/4-T1-121E-1%	STACKPOLE
R4	110-649-1	RESISTOR,FXD,MF, 649 Ω ,1%,0.25W		
R5	110-121-1	RESISTOR,FXD,MF, 121 Ω ,1%,0.25W	RN 1/4-T1-121E-1%	STACKPOLE
R6	110-365-1	RESISTOR,FXD,MF, 365 Ω ,1%,0.25W		
R7	110-287-1	RESISTOR,FXD,MF, 287 Ω ,1%,0.25W	RN 1/4-T1-287E-1%	STACKPOLE
R8	110-1K-1	RESISTOR,FXD,MF,1.0K Ω ,1%,.025W	RN 1/4-T1-1K-1%	STACKPOLE
R9	110-1M-1	RESISTOR,FXD,MF, 1M Ω ,1%,0.25W	RN 1/4-T1-1M-1%	STACKPOLE
R10	110-1M-1	RESISTOR,FXD,MF, 1M Ω ,1%,0.25W	RN 1/4-T1-1M-1%	STACKPOLE
TP1-8	702-17	TERMINAL,EYELET	20-2137D	VEROSPEED
VR1	54-919	IC,VOLTAGE REG,LT1085,ADJ	LT1085CT	LINEAR TECHNOLOGY
VR2	54-919	IC,VOLTAGE REG,LT1085,ADJ	LT1085CT	LINEAR TECHNOLOGY
VR3	54-919	IC,VOLTAGE REG,LT1085,ADJ	LT1085CT	LINEAR TECHNOLOGY

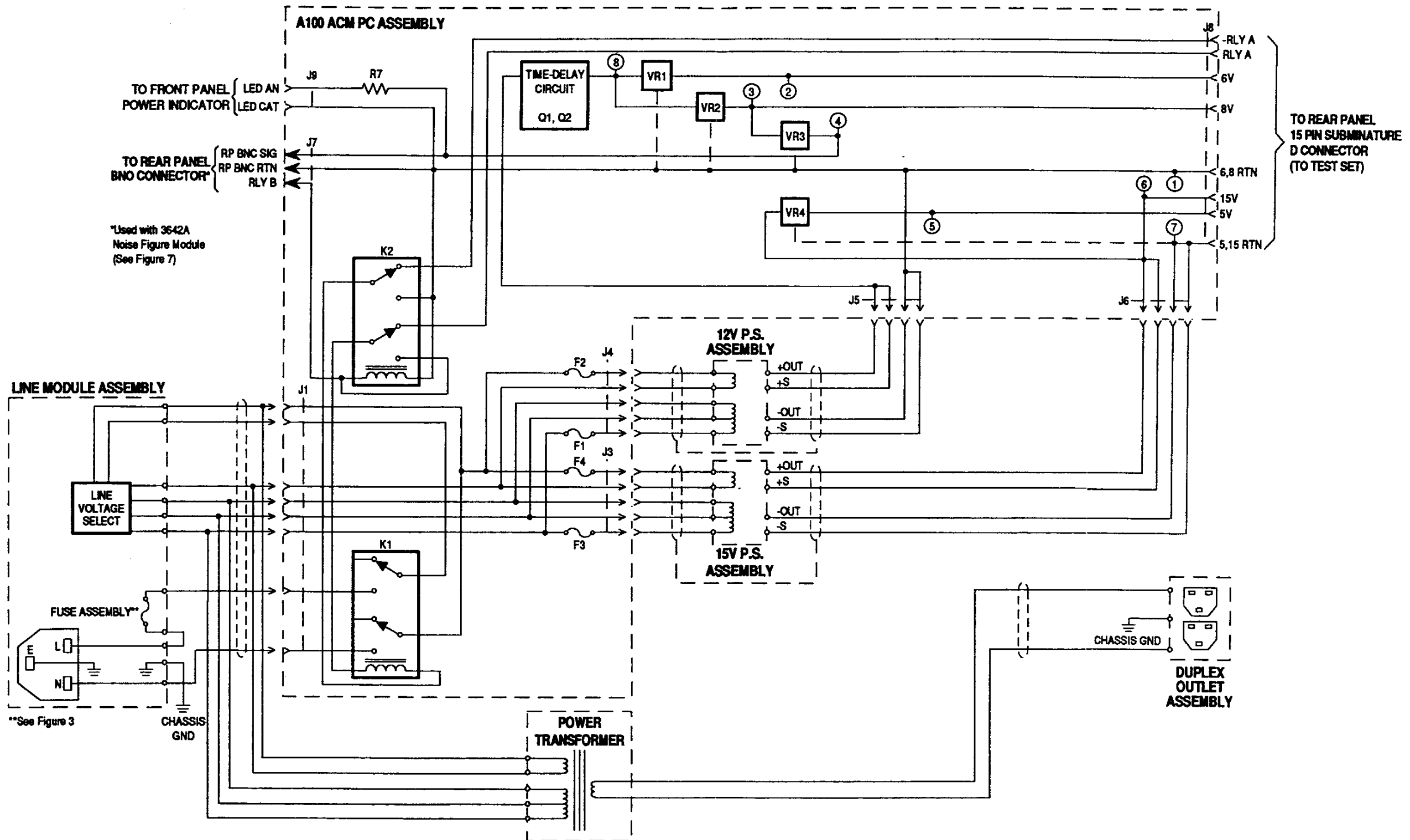
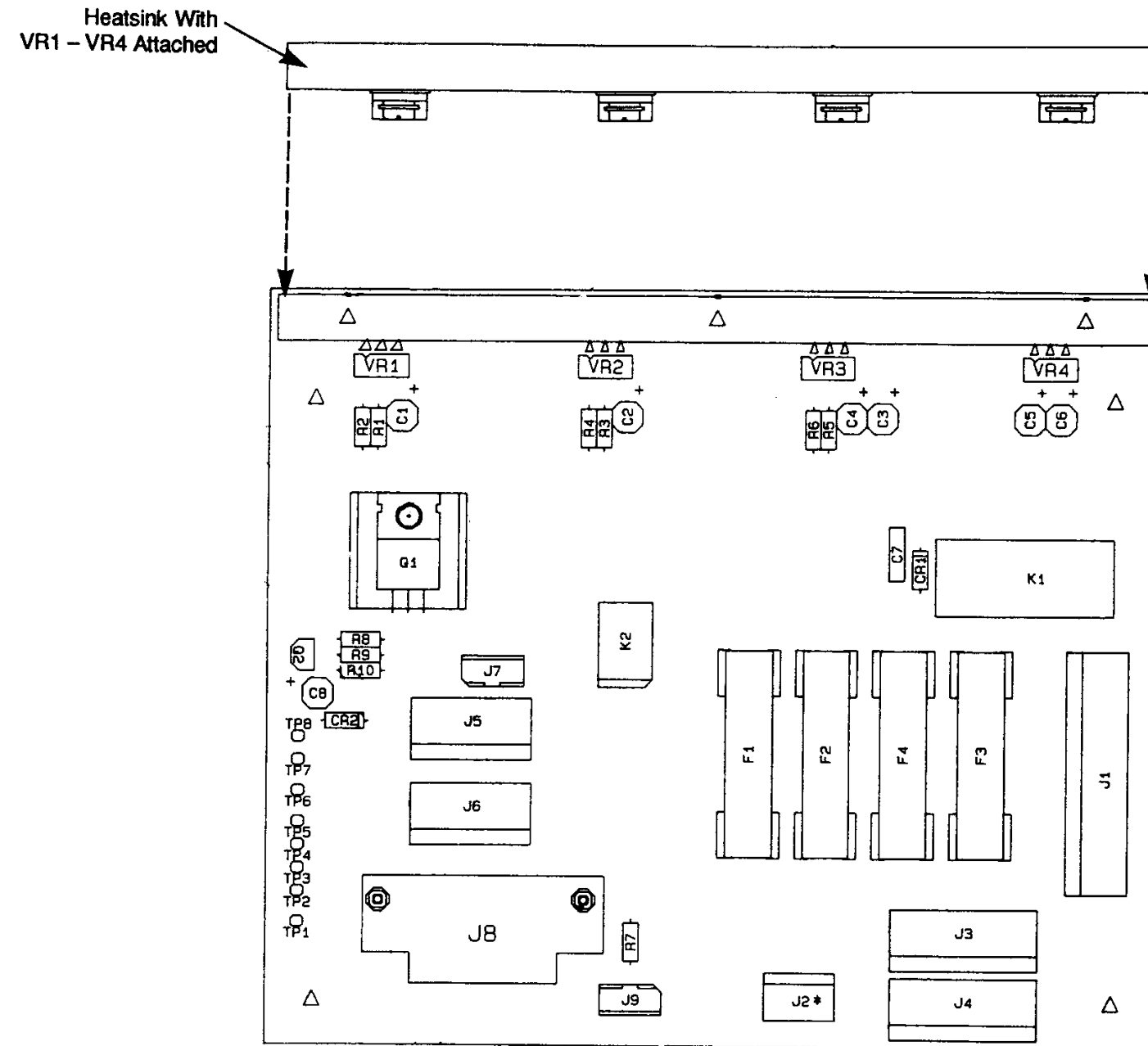
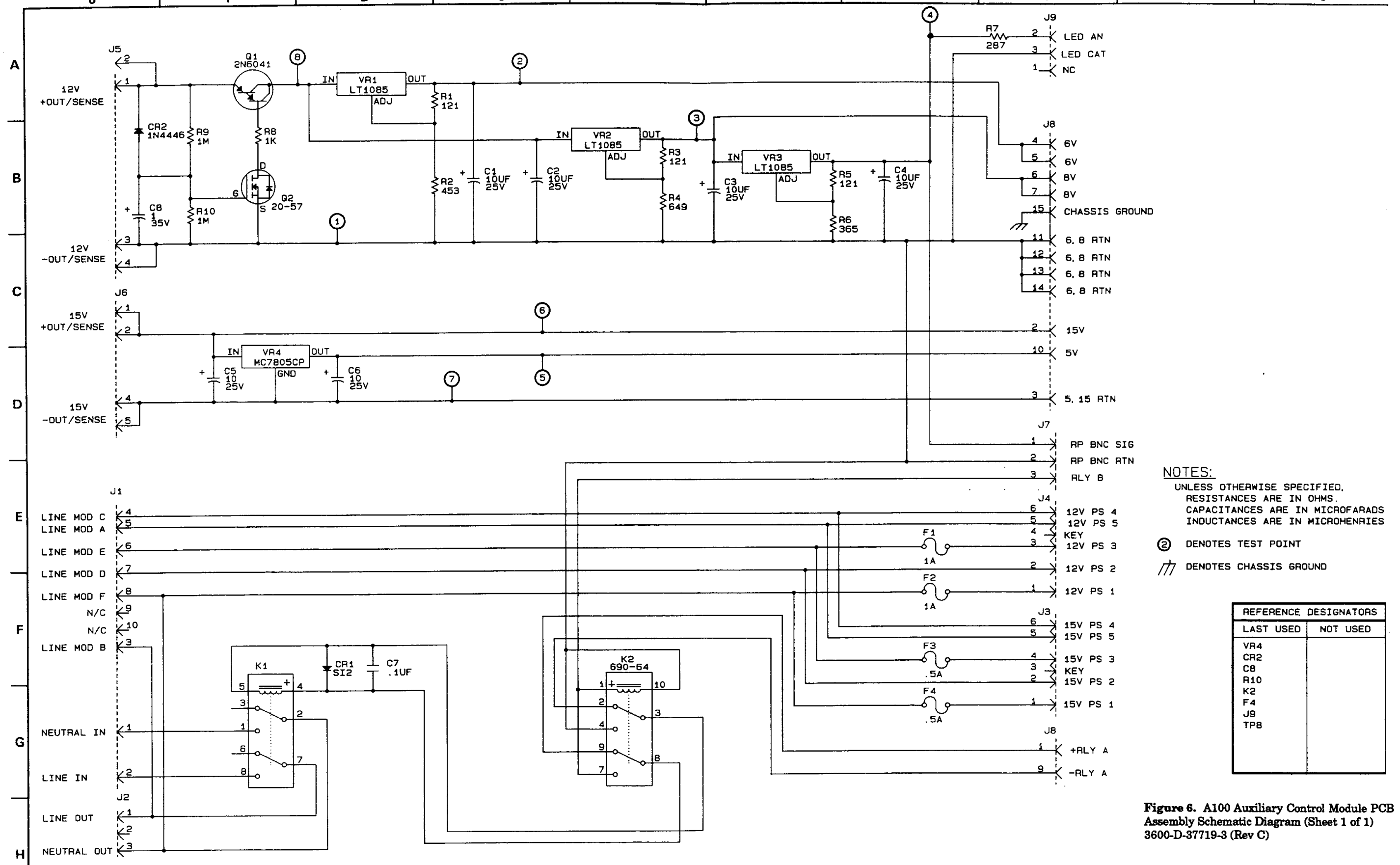

Figure 4. 360ACM Interconnection Diagram



NOTES:
 * J2 not used

Figure 5. A100 Auxiliary Control Module PCB
 Assembly Parts Locator Diagram (Sheet 1 of 1)
 3600-D-37719-3 (Rev C)



NOTES:
 UNLESS OTHERWISE SPECIFIED,
 RESISTANCES ARE IN OHMS.
 CAPACITANCES ARE IN MICROFARADS
 INDUCTANCES ARE IN MICROHENRIES

② DENOTES TEST POINT
 ⏏ DENOTES CHASSIS GROUND

REFERENCE DESIGNATORS	
LAST USED	NOT USED
VR4	
CR2	
C8	
R10	
K2	
F4	
J9	
TP8	

Figure 6. A100 Auxiliary Control Module PCB Assembly Schematic Diagram (Sheet 1 of 1) 3600-D-37719-3 (Rev C)

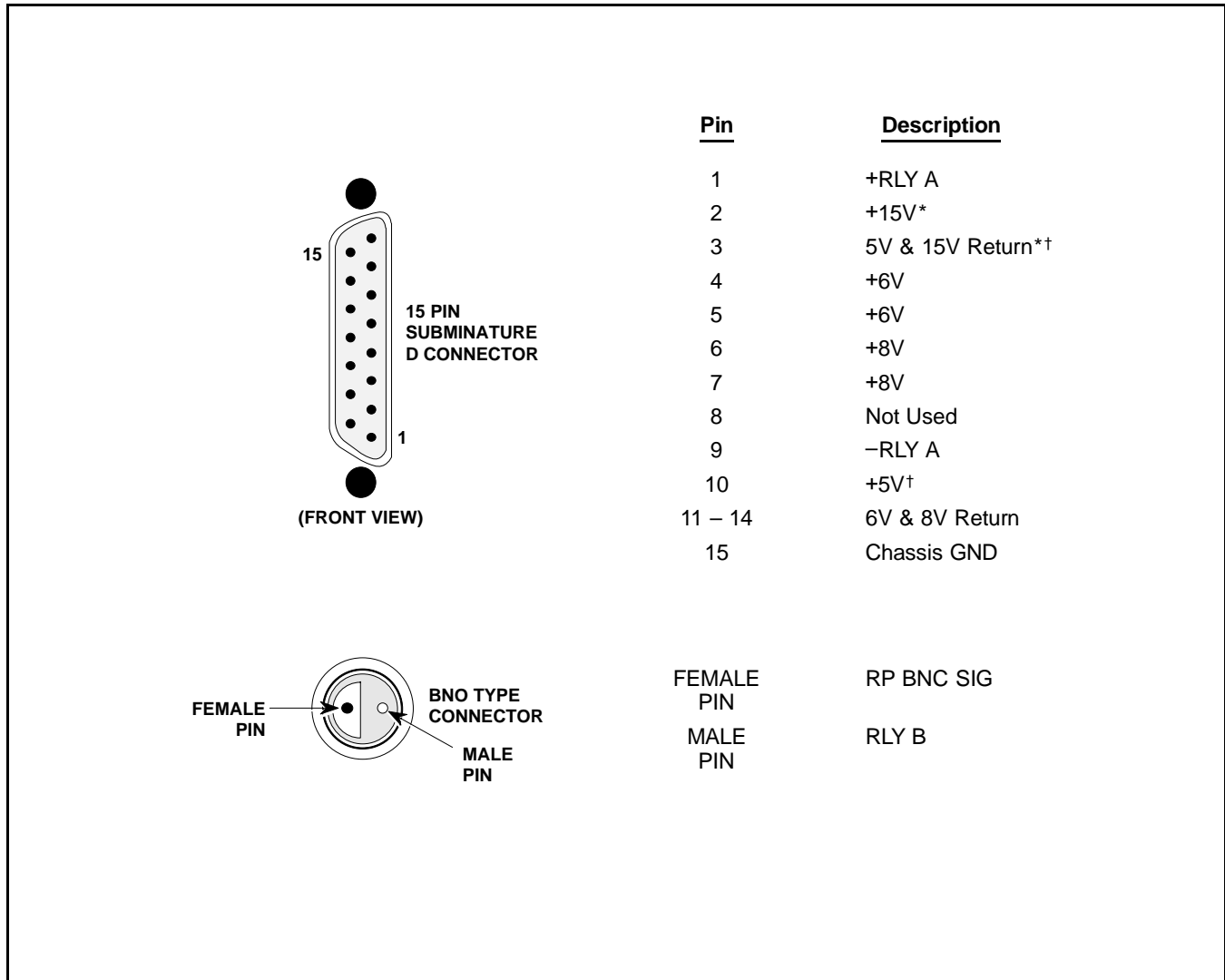

Figure 7. 360ACM Rear Panel Connector Pinouts